

VREX

Volumetric flow controller ATEX

PERFORMANCE DATA

- Operating temperature: 10 - 50° C
- Ambient temperature: 0-50°C
- Measuring range: 0 - 300 Pa
- Differential pressure range: 50-1000 Pa
- Volumetric flow range: 53 to 5794 m³/h
- Command signal: 0-10 V DC or 2-10 V DC
- Regulating the air velocity in the duct in the range of 2...13 m/s
- Housing leakage according to DIN EN 1751, class B
- Damper leaf leakage according to DIN EN 1751, class 3

SPECIAL FEATURES

- compact dimensions (up to NW 400 mm)
- position-independent installation possible
- low pressure loss
- for volumetric flow and linear pressure control of rooms or ducts
- simple commissioning and setting, without the need of additional setting devices at the controller
- with spring return actuator (if required)

TESTS AND STANDARDS

- **VDI 6022, Sheet 1:** Hygienic requirements of ventilation and air-conditioning systems
- **DIN EN 13779 (2007):** Ventilation of non-residential buildings
- **Leakage air: EN 1751 (2014-06)** Ventilation for buildings - Aerodynamic testing of damper and valves

APPROVALS AND CERTIFICATES

- RoHS 2002/95/EC
- 2014/34/EU ATEX (product directive)
- EMC 2004/108/EC

TABLE OF CONTENTS

Table of Contents.....	2
Overview of product versions.....	3
Function.....	3
Areas of application.....	4
Tests and standards.....	4
Processing.....	4
Available sizes.....	5
Useable volumetric flow ranges.....	5
Accessories.....	6
Accessories - Dimensions.....	6
Available sizes of accessories.....	7
Static minimum pressure difference.....	8
Radiated noise.....	8
Flow generated noise - Pressure loss 125 Pa /250 Pa.....	9
Flow generated noise - Pressure loss 500 Pa/1000 Pa.....	10
Radiated noise - Pressure loss 125 Pa/250 Pa.....	11
Radiated noise - Pressure loss 500 Pa / 1000 Pa.....	12
Flow generated noise -RS-Ex L=950 - Pressure loss 125 Pa/250 Pa.....	13
Flow generated noise -RS-Ex L=950 - Pressure loss 500 Pa/1000 Pa.....	14
Flow generated noise -RS-Ex L=1450 - Pressure loss 125 Pa/250 Pa.....	15
Flow generated noise -RS-Ex L=1450 - Pressure loss 500 Pa/1000 Pa.....	16
Flow generated noise -RS-Ex L=1950 - Pressure loss 125 Pa/250 Pa.....	17
Flow generated noise -RS-Ex L=1950 - Pressure loss 500 Pa/1000 Pa.....	18
Connection diagram of ATEX unit.....	19
Connection diagram of ATEX controller.....	19
Prior to mounting and commissioning.....	20
Installation information.....	21
Maintenance and service.....	21
Legend.....	22
Order code.....	22
Specification text.....	24
Type plate.....	24
Certificate of conformity.....	25
.....	26

OVERVIEW OF PRODUCT VERSIONS

VREX



Round volumetric flow controller

- for regulating the air velocity in the duct in the range of 2-13 m/s
- with ATEX unit

VREX-FD1 - with flat-bed acoustic cladding

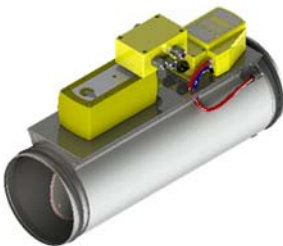

Round volumetric flow controller

- for regulating the air velocity in the duct in the range of 2-13 m/s
- with ATEX unit
- with 3 mm thick flat-bed acoustic cladding
- with sheet steel casing made of galvanised sheet steel

VREX-DS2 - with 20 mm acoustic cladding



Round volumetric flow controller

- for regulating the air velocity in the duct in the range of 2-13 m/s
- with ATEX unit
- with 20 mm thick acoustic cladding
- with sheet steel casing made of galvanised sheet steel

FUNCTION

A volumetric flow controller is used for pressure-independent volumetric flow regulation in ventilation and air-conditioning systems. It serves to keep the volumetric flow either constant within specified limits (CAV) or to control it variably (VAV).

The housing, measuring sensor, control damper, PID controller with pressure sensor and actuator form a closed control loop with feedback, allowing demand-dependent, energy-saving air-conditioning of the single rooms or areas of air-conditioning systems. When suitable electrical controller types are used, room or duct pressure regulation can be achieved.

The first adjustment of the V_{min} , V_{max} and V_{nenn} operating volumetric flows is done prior to delivery ex works in accordance with customer specifications. When these values are set, the functions of all volumetric flow controllers are also checked. The maximum deviation of the volumetric flows is +/- 5 %, relative to the nominal volumetric flow V_{nenn} .

For the measurement of the effective pressure, SCHAKO relies on a measuring principle based on aluminium measuring rods, in which for measuring the average values 6 measuring points each have been attached to the pressure and suction sides, using the median line method.

In comparison with measuring rods or measuring orifices having fewer measuring points, this gives higher accuracy, allowing the inflow area required in front of the volumetric flow controller to be minimised.

When using the controllers in systems with heavy dust contamination, suitable filters must be used.

Since the membrane zero point must not be changed in static sensors, the mounting instructions documented by the manufacturer must be adhered to. The volumetric flow controllers type VREX are not suitable for air containing sticky and greasy particles (e.g. kitchen exhaust air).

AREAS OF APPLICATION

- for supply and return air systems
- for hazardous areas of zones 1, 2, 21 and 22
- also for explosion group IIC in zones 1 and 2 (gases)
- Regulation components with ingress protection IP 66
- for constant CAV or variable VAV installations
- for positive control V_{min} , V_{mid} , V_{max} , "OPEN" or "CLOSED"
- for volumetric flow and linear pressure control
- Measuring range: 0...300 Pa
- at ambient temperatures 0 °C...20 °C to 50 °C, requirement: measuring air 0...+50°C/5...95% rH, non-condensing
- with command signal 0...10V DC, 2...10V DC,
- with supply voltage 24V AC / DC +/- 15%, 50/60Hz
- with DD varnish coating for aggressive media
- for regulating the air velocity in the duct in the range of 2...13 m/s
- can also be used with vertical axis

The round volumetric flow controller type VREX made of galvanised steel is suitable for use with aggressive components of polluted air (only with DD varnish coating or of 1.4301, 1.4571 stainless steel) and in areas subject to explosion hazards. The SCHAKO VREX has been approved for all gases in zone 1, zone 2, as well as for dusts in zones 21 and 22. The SCHAKO VREX can also be used in zones 1 and 2 of the explosion group IIC.

When connecting SCHAKO components to customer installations, any compatibility problems should be previously checked and solved on-site.

Additional information for defining explosion protection

(Hazardous zone 1 = Gases / Hazardous zone 2 = Dusts)

- Device group II: Use in the remaining hazardous areas, subdivided into categories:
 - Category 2 - occasional hazard for Zone 1 and Zone 21
 - Category 3 - rare / brief hazard for Zone 2 and 22

TESTS AND STANDARDS

The volumetric flow controller VREX... has been tested in accordance with the following guidelines:

Completed tests

- VDI 6022, Sheet 1: Hygienic requirements of ventilation and air-conditioning systems
- DIN EN 13779 (2007): Ventilation of non-residential buildings

Applied standards

- Leakage air: EN 1751 (2011-02)
- RoHS 2002/95/EC
- REACH 1907/2006
- EMC 2004/108/EC

PROCESSING

Housing

- Galvanised sheet steel
- Galvanised sheet steel with DD coating
- Stainless steel 1.4301 (-V2A) or 1.4571 (-V4A)

Damper blade

- Galvanised sheet steel
- Stainless steel 1.4301 (-V2A) or 1.4571 (-V4A)

Damper blade seal

- made of PUR, silicone-free
- model sealing airtight to DIN EN 1751

Damper bearing

- Brass

Measuring cross

- round aluminium measuring rods (in stainless steel model with DD varnish coating)

Model

- Round model, for spiral duct connection to DIN 24145, with damper blade seal for air-tight sealing (size \varnothing 125...400, to DIN EN 1751, class 3)

Controllers and actuators

The description of the fields of application and the technical data for the controller SCHISCHEK ExReg and for the actuator SCHISCHEK ExMax...-CY / -CYF can be found in the SCHISCHEK documentation at www.schischek.de

A098 = ATEX-NM-K2

Controller ExReg V300-A with actuator ExMax 5-10 Nm

A100 = ATEX-NM-F-K2

Controller ExReg V300-A with actuator ExMax 5-10 Nm and spring return

AVAILABLE SIZES

NW	øD	øD1	øD2
100	98	104	140
125	123	129	165
160	158	164	200
200	198	204	240
250	248	254	290
315	313	319	355
400	398	404	440

NW 100 - sealing airtight to DIN-EN 1751, class 2
 NW 125 - NW 400 sealing airtight to DIN-EN 1751, class 3.

Dimensions

VREX

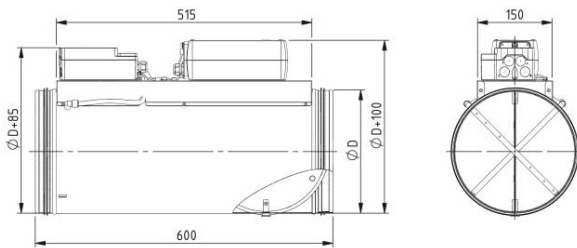

VREX-FD1

with flat-bed acoustic cladding

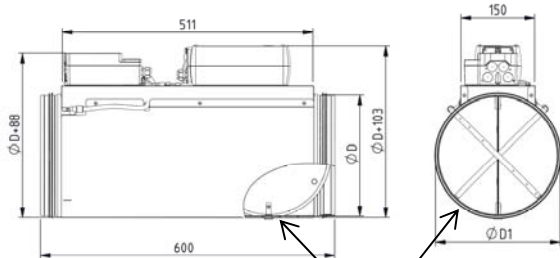

Flat-bed acoustic cladding

VREX-DS2

with 20 mm acoustic cladding

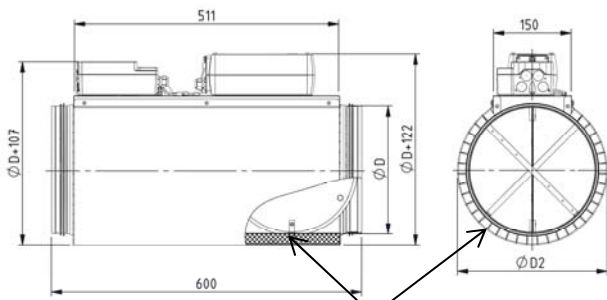

acoustic cladding with insulation 20 mm

USEABLE VOLUMETRIC FLOW RANGES

NW (mm)	V	V _{min} (2 m/s)	V _{max} (13 m/s)
100	m ³ /h	53	346
	l/s	15	96
125	m ³ /h	84	547
	l/s	23	152
160	m ³ /h	139	906
	l/s	39	251
200	m ³ /h	219	1427
	l/s	61	397
250	m ³ /h	345	2243
	l/s	96	623
315	m ³ /h	550	3578
	l/s	153	995
400	m ³ /h	891	5794
	l/s	248	1486

ATTENTION: important for parameterisation of the VREX

- The table of “useable volumetric flow ranges” corresponds to the complete measuring range.
- When the air volume drops below V_{min}, the correct functioning of the volumetric flow controller is no longer guaranteed.
- If only V_{max} is specified in the order, a variable volumetric flow controller will be delivered. The V_{min} value will be set to the value specified in the catalogue.
- If only one air volume is specified in the order (as V_{min} or V_{kon}), then the volumetric flow controller will be delivered as a constant volumetric flow controller. The volume specified in the order is set to the V_{min} value, and the V_{max} value is set to 100%.
- The air volumes V_{min} and V_{max} and the operating mode 0/2-10 V can be changed directly at the controller within the nominal volumetric flow.
- For the parameter setting of the regulation components, an air density of 1.2 kg/m³ has been taken into account.
- If no values are specified in the order, the controller will be programmed with the standard values in table p. 5.

ACCESSORIES

Metu flange (-MF1, MF2)

- on both sides, duct flange type MF1, galvanised steel
- on both sides, duct flange type MF2, stainless steel V2A, 1.4301

Counter flange (-GF) (pair), loose

- on both sides, to Metu flange (must be ordered separately)

Tension ring (-SR) (pair), loose

- to connect Metu flange to counter flange (must be ordered separately)

Flat flange (-FF1, FF2)

- on both sides, according to DIN 24 154/5. type FF1, galvanised steel
- on both sides, according to DIN 24 154/5. type FF2, stainless steel V2A, 1.4301

Acoustic cladding (-DS 2)

- made of sound-absorbing, insulating 20 mm material with sheet steel covering made of galvanised sheet steel, non-flammable according to DIN 4102-17.

Flat-bed acoustic cladding (-FD1)

- made of sound-absorbing, insulating 3 mm material with sheet steel covering made of galvanised sheet steel (standard)

Rubber lip seal (-GD1)

- on both sides, special rubber.

Duct silencer (-RS-Ex)

- rigid model
- Outer jacket and perforated plate made of galvanised sheet steel
- mineral wool filling

Please note!

Counter flanges, tension rings or duct silencers must be ordered separately and are supplied loose!

ACCESSORIES - DIMENSIONS

Metu flange (-MF1/-MF2) / counter flange (-GF) / tension ring (-SR) on both sides

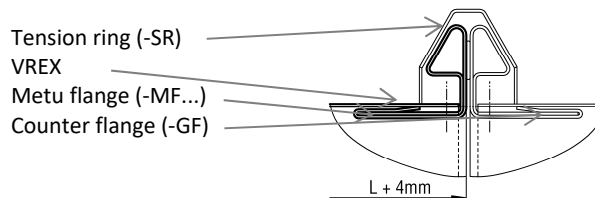

Flat flange (-FF1/-FF2), on both sides

to DIN 24154/5

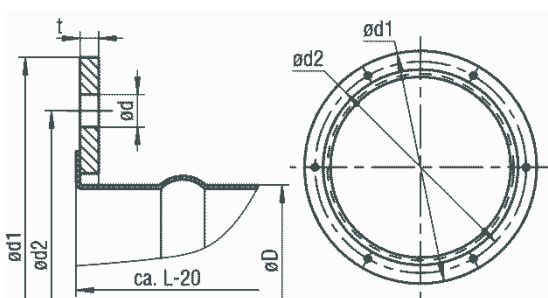

Rubber lip seal (-GD1)

Detail X

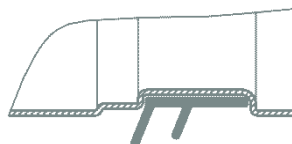

Duct silencer (RS-Ex)

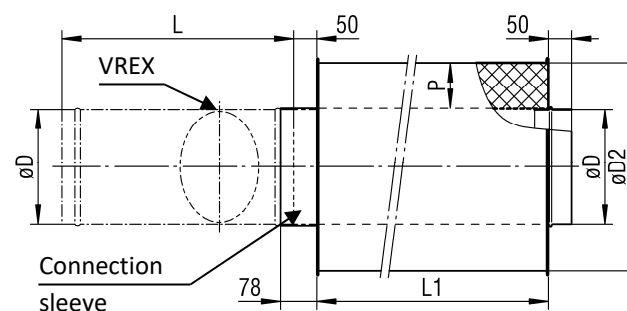

AVAILABLE SIZES OF ACCESSORIES

-FF1 / -FF2 - flat flange

NW	øD	ød1	ød2	ød	LOA	t
100	100	154	129	7	4	3
125	125	177	155	7	4	3
160	160	222	194	7	6	4
200	200	263	235	7	6	4
250	250	313	286	7	6	4
315	315	388	356	9.5	8	5
400	400	474	438	9.5	12	5

-RS-Ex - Duct silencer

NW	L	øD	øD2	
			P (mm)	
			50	100
100	340	98	200	300
125	360	123	225	325
160	410	158	260	360
200	450	198	300	400
250	500	248	350	450
315	600	313	415	515
400	700	398	500	600

Note on packing thicknesses:

- L1=500: All packing thicknesses available in all nominal sizes
- L1=950: All packing thicknesses available in all nominal sizes
- L1=1450: All packing thicknesses available in all nominal sizes.
 Exceptions: packing thickness of 100 mm is not available for NW100 and NW125.
- L1=1950: The following combinations are available:
 - packing thickness of 50 mm is only available for NW100-125.
 - packing thickness of 100 mm is only available for NW160-250.

STATIC MINIMUM PRESSURE DIFFERENCE

NW	v_k (m/s)	V (m ³ /h)	V [l/s]	$\Delta p_{t \min}$ (Pa)
100	3	80	23	20
	6	160	44	25
	9	239	66	50
	12	319	89	70
125	3	126	35	20
	6	252	70	20
	9	379	105	40
	12	505	140	60
160	3	209	59	20
	6	418	116	20
	9	627	174	35
	12	836	232	55
200	3	329	92	15
	6	658	183	20
	9	987	274	25
	12	1316	366	50
250	3	518	144	15
	6	1034	287	15
	9	1552	431	20
	12	2069	575	30
315	3	825	230	15
	6	1651	459	15
	9	2476	688	20
	12	3301	917	25
400	3	1337	372	15
	6	2672	742	15
	9	4009	1114	20
	12	5345	1485	25

RADIATED NOISE

with insulated connections on both sides

f_m (Hz)	125	250	500	1000	2000	4000
NW	ΔL_W [dB/oct]					
100	18	22	28	38	38	38
125	18	19	27	37	37	37
160	18	14	26	32	33	33
200	14	15	27	32	34	37
250	11	18	28	33	37	40
315	12	20	29	34	40	42

(50 mm mineral wool insulation), (sheet thickness 1 mm)

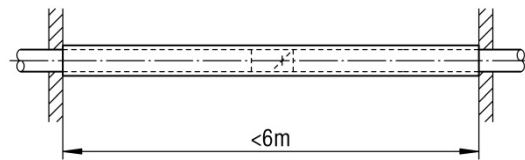

with up to 6 m of spiral duct according to DIN 24145

f_m (Hz)	125	250	500	1000	2000	4000
NW	ΔL_W [dB/oct]					
100	23	24	24	22	18	15
125	19	23	23	19	18	14
160	18	20	23	18	16	12
200	15	18	21	18	14	11
250	13	16	18	18	14	14
315	11	13	19	19	11	14

$$L_{Wabst} = L_W - \Delta L_W \text{ [dB]}$$

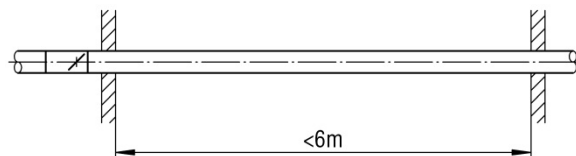

with acoustic cladding

f_m (Hz)	125	250	500	1000	2000	4000
NW	ΔL_W [dB/oct]					
100-315	7	4	4	9	13	15

20 mm mineral wool insulation. With a straight supply and return air flow of 3 m each, the VREX acoustic cladding reduces the radiated noise by 8 dB(A).

FLOW GENERATED NOISE - PRESSURE LOSS 125 PA /250 PA

NW	v _K (m/s)	V (m ³ /h) [l/s]		Δp _t = 125 Pa									L _{WA} [dB(A)]	Δp _t = 250 Pa									L _{WA} [dB(A)]
				L _w [dB/oct]										L _w [dB/oct]									
				f _m (Hz)										f _m (Hz)									
63	125	250	500	1000	2000	4000	8000	63	125	250	500	1000	2000	4000	8000	L _{WA} [dB(A)]							
100	3	80	22	33	40	37	35	34	33	32	33	39	37	43	43	41	39	38	37	31	46		
	6	160	44	41	54	49	45	40	36	35	34	45	43	57	54	50	46	44	43	36	53		
	9	239	66	45	55	51	45	40	37	25	35	49	48	63	59	57	51	48	46	39	56		
	12	319	89	51	56	55	51	45	40	37	35	52	58	67	63	58	53	49	47	42	59		
125	3	126	35	40	42	39	37	36	35	34	36	41	45	45	45	43	41	40	39	39	48		
	6	252	70	48	56	51	48	42	38	37	37	47	51	59	56	52	48	46	45	44	55		
	9	379	105	52	57	53	47	42	39	37	38	51	56	65	61	59	53	50	48	47	58		
	12	505	140	58	58	57	53	47	42	39	38	54	66	69	65	60	55	51	49	56	61		
160	3	209	58	43	44	41	39	38	37	36	37	45	48	47	47	45	43	42	41	38	50		
	6	418	116	51	58	53	49	44	40	39	38	49	54	61	58	54	50	48	47	42	57		
	9	627	174	55	59	55	49	44	41	39	39	53	59	67	63	61	55	52	50	45	60		
	12	836	232	61	60	59	55	49	44	41	39	56	69	71	67	62	57	53	51	48	63		
200	3	329	91	49	46	43	41	40	39	38	37	45	54	49	49	47	45	44	43	44	52		
	6	658	183	57	60	55	51	46	42	41	39	51	60	63	60	56	52	50	49	49	59		
	9	987	274	61	61	57	51	46	43	41	40	55	65	69	65	53	67	54	52	52	62		
	12	1316	366	67	62	61	57	51	46	43	40	58	75	73	69	64	59	55	53	55	65		
250	3	517	144	53	48	45	43	42	41	40	39	47	57	51	51	49	47	46	45	45	54		
	6	1034	287	61	62	57	53	48	44	43	40	53	63	65	52	58	54	52	51	50	61		
	9	1552	431	65	53	59	53	48	45	43	41	57	68	71	67	65	59	56	54	53	64		
	12	2069	575	71	64	63	59	53	48	54	51	60	78	75	71	66	61	57	55	56	67		
315	3	825	229	55	50	47	45	44	43	42	39	49	57	47	42	44	45	47	40	45	56		
	6	1651	459	63	64	59	55	50	46	45	41	55	63	61	53	53	52	53	46	50	63		
	9	2476	688	67	65	61	55	50	47	45	42	49	68	67	64	61	58	56	54	53	66		
	12	3301	917	73	66	65	61	55	50	47	42	62	78	71	62	60	58	57	56	56	69		
400	3	1336	371	57	52	49	47	46	45	44	42	51	64	55	55	53	51	50	49	49	58		
	6	2672	742	65	66	61	57	52	48	47	43	57	70	69	66	62	58	56	55	54	65		
	9	4009	1114	69	67	63	57	52	49	47	44	61	75	75	71	69	63	60	58	57	68		
	12	5345	1485	75	68	67	63	57	52	49	44	64	85	79	75	70	65	61	59	60	71		

FLOW GENERATED NOISE - PRESSURE LOSS 500 PA/1000 PA

NW	v _K (m/s)	V (m ³ /h) [l/s]		Δp _t = 500 Pa									Δp _t = 1000 Pa												
				L _w [dB/oct]											L _w [dB/oct]										
				f _m (Hz)								L _{WA} [dB(A)]	f _m (Hz)								L _{WA} [dB(A)]				
63	125	250	500	1000	2000	4000	8000	63	125	250	500		1000	2000	4000	8000									
100	3	80	22	41	48	47	46	45	44	41	41	52	58	55	52	52	53	52	50	50	57				
	6	160	44	45	61	58	56	63	52	47	46	58	62	61	61	60	59	58	56	57	64				
	9	239	66	53	69	66	61	57	54	51	50	62	69	69	68	65	64	64	59	59	70				
	12	319	89	56	71	67	63	59	56	54	52	65	73	70	71	70	68	67	63	63	76				
125	3	126	35	49	50	49	48	47	46	43	42	54	60	57	54	54	55	54	52	51	59				
	6	252	70	53	63	60	58	55	54	49	47	60	64	63	63	62	61	60	58	58	66				
	9	379	105	61	71	68	63	59	56	53	51	64	71	71	70	67	66	66	61	60	72				
	12	505	140	64	73	69	65	61	58	56	53	67	75	74	73	72	70	69	65	64	78				
160	3	209	58	55	52	51	50	49	48	45	46	56	62	59	56	56	57	56	54	53	61				
	6	418	116	59	65	62	60	57	56	51	51	62	66	65	65	64	63	62	60	60	68				
	9	627	174	67	73	70	65	61	58	55	55	66	73	73	72	69	68	68	63	62	74				
	12	836	232	70	75	71	67	63	60	58	57	69	77	76	75	74	72	71	67	66	80				
200	3	329	91	60	54	53	52	51	50	47	47	58	64	61	58	58	59	58	56	55	63				
	6	658	183	64	67	64	62	49	48	43	42	64	68	67	67	66	65	64	62	62	70				
	9	987	274	72	75	72	67	63	60	57	56	68	75	75	74	71	70	70	65	64	76				
	12	1316	366	75	77	73	69	65	62	60	59	71	79	78	77	76	74	73	69	68	82				
250	3	517	144	63	56	55	54	53	52	49	49	60	66	63	60	60	61	60	58	57	65				
	6	1034	287	67	69	66	64	61	60	55	54	66	70	69	69	68	67	66	64	64	72				
	9	1552	431	75	77	74	69	65	62	59	58	70	77	77	76	73	72	72	67	66	78				
	12	2069	575	78	79	75	71	67	64	62	60	73	81	80	79	78	76	75	71	70	84				
315	3	825	229	66	58	57	56	55	54	51	51	62	68	65	62	62	63	62	60	59	67				
	6	1651	459	70	71	68	66	63	62	57	56	68	72	71	71	70	69	68	66	66	74				
	9	2476	688	78	79	76	71	67	64	61	60	72	79	79	78	75	74	74	69	68	80				
	12	3301	917	81	81	77	73	69	66	64	62	75	83	82	81	80	78	77	73	72	86				
400	3	1336	371	59	60	59	58	57	56	53	53	64	70	67	64	64	65	64	62	61	69				
	6	2672	742	73	73	70	68	65	64	59	58	70	74	73	73	72	71	70	58	58	76				
	9	4009	1114	81	81	78	73	69	66	63	62	74	81	81	80	77	76	76	71	71	82				
	12	5345	1485	84	83	79	75	71	68	66	64	77	85	84	83	82	80	79	75	75	88				

RADIATED NOISE - PRESSURE LOSS 125 PA/250 PA

NW	v _K (m/s)	V (m ³ /h) [l/s]		Δp _t = 125 Pa									Δp _t = 250 Pa								
				L _w [dB/oct]								L _{WA} [dB(A)]	L _w [dB/oct]								L _{WA} [dB(A)]
				f _m (Hz)									f _m (Hz)								
				63	125	250	500	1000	2000	4000	8000		63	125	250	500	1000	2000	4000	8000	
100	3	80	22	8	22	21	22	18	20	21	22	24	19	25	27	28	23	25	26	20	31
	6	160	44	23	36	33	32	24	23	24	23	31	25	39	38	37	30	31	32	25	38
	9	239	66	27	37	35	32	24	24	24	23	34	30	45	43	44	35	35	35	28	42
	12	319	89	33	38	39	38	29	27	26	24	37	40	49	47	45	37	36	36	31	44
125	3	126	35	22	24	23	20	20	22	25	27	26	27	27	29	26	25	27	30	30	33
	6	252	70	30	38	35	30	26	25	28	28	33	33	41	40	35	32	33	36	35	40
	9	379	105	34	39	37	30	26	26	28	29	36	37	47	45	42	37	37	39	38	44
	12	505	140	40	40	41	36	31	29	30	29	39	48	51	49	43	39	38	40	38	46
160	3	209	58	25	26	27	21	23	24	27	28	28	30	29	33	27	28	29	32	30	35
	6	418	116	33	40	39	31	29	27	30	29	35	36	43	44	36	35	35	38	33	42
	9	627	174	37	41	41	31	29	28	30	30	38	41	49	49	43	40	39	41	36	46
	12	836	232	43	42	45	37	34	31	32	32	41	51	53	53	44	42	40	42	39	48
200	3	329	91	36	33	30	24	25	28	30	30	32	41	36	36	30	30	33	35	36	39
	6	658	183	45	47	42	34	31	31	33	31	38	47	50	47	39	37	39	41	41	46
	9	987	274	48	48	44	34	31	32	33	32	42	52	56	52	46	42	43	44	44	49
	12	1316	366	54	49	48	40	36	35	35	32	45	62	60	56	57	44	44	45	47	52
250	3	517	144	45	40	30	27	28	30	32	31	35	49	43	36	33	33	35	37	37	42
	6	1034	287	54	54	42	37	34	33	35	32	41	55	57	47	42	40	41	43	42	49
	9	1552	431	57	55	44	37	34	34	35	33	45	60	63	52	49	45	45	46	45	52
	12	2069	575	63	56	48	43	39	37	37	33	48	70	67	56	50	47	46	47	48	55
315	3	825	229	47	42	32	29	30	33	34	31	37	45	32	27	28	31	37	32	37	44
	6	1651	459	55	56	44	39	36	36	37	33	43	48	46	38	37	38	43	38	42	51
	9	2476	688	59	57	46	39	36	37	37	34	47	53	52	49	45	44	46	46	45	54
	12	3301	917	65	58	50	45	41	40	39	34	50	63	56	47	44	44	47	48	48	57
400	3	1336	371	47	42	37	33	36	33	37	35	40	54	45	43	39	41	38	42	42	47
	6	2672	742	55	56	49	43	42	36	40	36	46	60	59	54	48	48	44	48	47	54
	9	4009	1114	59	57	51	43	42	37	40	37	50	65	65	59	55	53	48	51	50	57
	12	5345	1485	65	58	55	49	47	40	52	37	53	75	69	63	56	55	49	52	53	60

RADIATED NOISE - PRESSURE LOSS 500 PA / 1000 PA

NW	v _K (m/s)	V (m ³ /h) [l/s]		Δp _t = 500 Pa									Δp _t = 1000 Pa												
				L _w [dB/oct]										L _{WA} [dB(A)]	L _w [dB/oct]										L _{WA} [dB(A)]
				f _m (Hz)											f _m (Hz)										
				63	125	250	500	1000	2000	4000	8000		63	125	250	500	1000	2000	4000	8000					
100	3	80	22	23	30	31	33	29	31	30	30	37	40	37	36	39	37	39	39	39	39	42			
	6	160	44	27	43	42	43	37	39	36	35	43	44	43	45	47	43	45	45	46	46	49			
	9	239	66	35	51	50	48	41	41	40	39	47	51	51	52	53	48	51	48	49	55				
	12	319	89	38	53	51	50	43	43	43	41	50	55	54	55	58	52	56	52	53	61				
125	3	126	35	31	32	33	31	31	33	34	33	39	42	39	38	37	39	41	43	42	44				
	6	252	70	35	45	44	41	39	41	40	38	45	46	45	47	45	47	49	49	51					
	9	379	105	43	53	52	46	43	43	44	42	49	53	53	54	51	50	53	52	52	57				
	12	505	140	46	55	53	48	45	45	47	44	52	57	56	57	56	54	58	56	56	63				
160	3	209	58	37	34	37	32	34	35	36	37	41	47	44	42	39	41	44	46	45	47				
	6	418	116	41	47	48	42	42	43	42	42	47	51	50	51	47	47	50	52	52	54				
	9	627	174	49	55	56	47	46	45	46	46	51	58	58	58	53	52	56	55	55	60				
	12	836	232	52	57	57	49	48	47	49	48	54	62	61	61	58	56	61	59	59	66				
200	3	329	91	47	41	40	35	36	39	39	39	45	51	48	45	41	44	47	48	47	50				
	6	658	183	51	54	51	45	44	47	45	44	51	55	54	54	49	50	53	54	54	57				
	9	987	274	59	62	59	50	48	49	49	48	55	62	62	61	55	55	59	77	57	63				
	12	1316	366	62	64	60	52	50	51	52	51	58	66	65	64	60	59	64	61	61	69				
250	3	517	144	55	48	40	38	39	41	41	41	48	58	55	45	44	47	49	50	49	53				
	6	1034	287	59	61	51	48	47	49	47	46	54	62	61	54	52	53	55	56	56	60				
	9	1552	431	67	69	59	53	51	51	51	50	58	69	69	61	58	58	61	59	59	66				
	12	2069	575	70	71	60	55	53	53	54	52	61	73	72	64	63	62	66	63	63	72				
315	3	825	229	58	50	42	40	41	44	43	43	50	60	57	47	46	49	52	52	51	55				
	6	1651	459	62	63	53	50	49	52	49	48	56	64	63	56	54	55	58	58	58	62				
	9	2476	688	70	71	61	55	53	54	53	52	60	71	71	63	60	60	64	61	61	68				
	12	3301	917	73	73	62	57	55	56	56	54	63	75	74	66	65	64	69	65	65	74				
400	3	1336	371	59	50	47	44	47	44	46	46	53	62	57	52	50	55	52	55	54	58				
	6	2672	742	63	63	58	54	55	52	52	51	59	66	63	61	58	61	58	61	61	65				
	9	4009	1114	71	71	66	59	59	54	56	55	63	73	72	68	64	66	64	64	64	71				
	12	5345	1485	74	73	67	61	61	56	59	57	66	77	75	71	69	70	69	68	68	77				

FLOW GENERATED NOISE -RS-EX L=950 - PRESSURE LOSS 125 PA/250 PA

NW	v _k (m/s)	V (m ³ /h) [l/s]			Δp _r = 125 Pa								L _{WA} [dB(A)]	Δp _r = 250 Pa								L _{WA} [dB(A)]
					L _w [dB/oct]									L _w [dB/oct]								
					f _m (Hz)									f _m (Hz)								
					63	125	250	500	1000	2000	4000	8000		63	125	250	500	1000	2000	4000	8000	
100	3	80	22	28	28	<15	<15	<15	<15	<15	<15	15	32	31	20	<15	<15	<15	<15	<15	18	
	6	160	44	36	42	26	<15	<15	<15	<15	<15	26	38	45	31	<15	<15	<15	<15	15	30	
	9	239	66	40	43	28	<15	<15	<15	<15	<15	28	43	51	36	21	<15	<15	<15	18	35	
	12	319	89	46	44	32	15	<15	<15	<15	<15	30	53	55	40	22	<15	<15	<15	21	40	
125	3	126	35	36	31	18	<15	<15	<15	<15	17	19	41	34	24	<15	<15	<15	<15	20	23	
	6	252	70	44	45	30	<15	<15	<15	<15	18	30	47	48	35	19	<15	<15	<15	25	34	
	9	379	105	48	46	32	<15	<15	<15	<15	19	31	52	54	40	26	<15	<15	16	28	39	
	12	505	140	54	47	36	20	<15	<15	<15	19	34	62	58	44	27	<15	<15	17	27	43	
160	3	209	58	39	34	23	<15	<15	<15	<15	21	23	44	37	29	17	<15	<15	15	21	26	
	6	418	116	47	48	35	21	<15	<15	<15	22	33	50	51	40	26	<15	<15	21	26	37	
	9	627	174	51	50	41	27	<15	<15	<15	23	35	55	57	45	33	<15	<15	24	29	43	
	12	836	232	57	50	41	27	<15	<15	15	23	37	65	61	49	34	16	<15	25	32	47	
200	3	329	91	46	37	28	17	<15	<15	16	25	28	51	40	34	23	<15	<15	21	31	33	
	6	658	183	54	51	40	27	<15	<15	19	26	37	57	54	45	32	17	<15	27	36	42	
	9	987	274	58	52	42	27	<15	<15	19	27	39	62	60	50	39	22	<15	30	39	47	
	12	1316	366	64	53	46	33	16	<15	21	27	42	72	64	54	40	24	<15	31	42	52	
250	3	517	144	50	41	32	23	<15	<15	20	28	32	54	44	38	29	16	<15	25	34	37	
	6	1034	287	58	55	44	33	17	<15	23	29	41	60	58	49	38	23	17	31	39	46	
	9	1552	431	62	56	46	33	17	<15	23	30	43	65	64	54	45	28	21	34	42	51	
	12	2069	575	68	57	50	39	22	<15	25	30	47	75	68	58	46	30	22	35	45	55	
315	3	825	229	52	44	37	28	17	<15	25	30	35	54	51	32	27	18	16	23	36	37	
	6	1651	459	60	58	49	38	23	15	28	32	45	60	55	43	36	25	22	29	41	44	
	9	2476	688	64	59	51	38	23	16	28	33	47	65	61	54	44	31	25	37	44	50	
	12	3301	917	70	60	55	44	28	19	30	33	50	75	67	52	43	31	26	39	47	54	
400	3	1336	371	54	47	40	33	23	18	29	35	39	61	50	46	39	28	23	34	42	45	
	6	2672	742	62	61	52	43	29	21	32	36	48	67	64	57	48	35	29	40	47	53	
	9	4009	1114	62	61	52	43	29	21	32	36	50	72	70	62	55	40	33	43	50	69	
	12	5345	1485	66	62	54	43	29	22	32	37	53	82	74	66	56	42	34	44	53	63	

FLOW GENERATED NOISE -RS-EX L=950 - PRESSURE LOSS 500 PA/1000 PA

NW	v _K (m/s)	V (m ³ /h) [l/s]		Δp _t = 500 Pa									Δp _t = 1000 Pa								
				L _w [dB/oct]								L _{WA} [dB(A)]	L _w [dB/oct]								L _{WA} [dB(A)]
				f _m (Hz)									f _m (Hz)								
				63	125	250	500	1000	2000	4000	8000		63	125	250	500	1000	2000	4000	8000	
100	3	80	22	36	36	24	<15	<15	<15	<15	20	23	53	43	29	16	<15	<15	16	29	32
	6	160	44	40	49	35	20	<15	<15	<15	25	34	57	49	38	24	<15	<15	22	36	39
	9	239	66	48	57	43	25	<15	<15	17	29	42	64	57	45	29	<15	<15	25	38	44
	12	319	89	51	59	44	27	<15	<15	20	31	44	68	58	48	34	18	17	29	42	47
125	3	126	35	45	39	28	15	<15	<15	<15	23	27	56	46	33	21	<15	<15	20	32	35
	6	252	70	49	52	39	25	<15	<15	17	28	37	60	52	42	29	<15	<15	26	39	42
	9	379	105	57	60	47	30	<15	<15	21	32	45	67	60	49	34	16	16	29	41	48
	12	505	140	60	62	48	32	<15	<15	24	34	47	71	63	52	39	20	19	33	45	51
160	3	209	58	51	42	33	22	<15	<15	19	30	33	58	49	38	28	16	<15	28	37	40
	6	418	116	55	55	44	32	16	<15	25	35	42	62	55	47	36	22	<15	34	44	46
	9	627	174	63	63	52	37	20	<15	29	39	49	69	63	54	41	27	20	37	46	51
	12	836	232	66	65	53	39	22	<15	32	41	51	73	66	57	46	31	23	41	50	55
200	3	329	91	57	45	38	28	16	<15	25	34	37	61	52	43	34	24	17	34	42	44
	6	658	183	61	58	49	38	24	17	31	39	46	65	48	52	42	30	23	40	49	51
	9	987	274	69	66	57	43	28	19	35	43	53	72	66	59	47	35	29	43	51	56
	12	1316	366	72	68	58	45	30	21	38	46	55	76	69	62	52	39	32	47	55	59
250	3	517	144	60	49	42	34	22	17	29	38	41	63	56	47	40	30	25	38	46	48
	6	1034	287	64	62	53	44	30	25	35	43	50	67	62	56	48	36	31	44	53	55
	9	1552	431	72	70	61	49	34	27	39	47	57	74	70	63	53	41	37	47	55	60
	12	2069	575	75	72	62	51	36	29	42	49	59	78	73	66	58	45	40	51	59	64
315	3	825	229	63	52	57	39	28	23	34	42	45	65	59	52	45	36	31	43	50	52
	6	1651	459	67	52	47	39	28	23	34	42	54	69	65	61	53	42	37	49	57	59
	9	2476	688	75	73	66	54	40	33	44	51	61	76	73	68	58	47	43	52	59	64
	12	3301	917	78	75	67	56	42	35	47	53	63	80	76	71	63	51	46	56	63	68
400	3	1336	371	56	55	50	44	34	29	38	46	49	67	62	55	50	42	37	47	54	56
	6	2672	742	70	68	61	54	42	37	44	51	58	71	68	64	58	48	43	53	61	63
	9	4009	1114	78	76	69	59	46	39	48	55	65	78	76	71	63	53	49	56	64	68
	12	5345	1485	81	78	70	61	48	41	51	57	66	82	79	74	68	57	52	60	68	72

FLOW GENERATED NOISE -RS-EX L=1450 - PRESSURE LOSS 125 PA/250 PA

NW	v _k (m/s)	V (m ³ /h) [l/s]			Δp _r = 125 Pa								L _{WA} [dB(A)]	Δp _r = 250 Pa							
					L _w [dB/oct]									L _w [dB/oct]							
					f _m (Hz)									f _m (Hz)							
					63	125	250	500	1000	2000	4000	8000		63	125	250	500	1000	2000	4000	8000
100	3	80	22	25	18	<15	<15	<15	<15	<15	<15	7	29	21	<15	<15	<15	<15	<15	<15	8
	6	160	44	33	32	<15	<15	<15	<15	<15	<15	16	35	35	<15	<15	<15	<15	<15	<15	19
	9	239	66	37	33	<15	<15	<15	<15	<15	<15	18	40	41	15	<15	<15	<15	<15	<15	25
	12	319	89	43	34	<15	<15	<15	<15	<15	<15	20	50	45	19	<15	<15	<15	<15	<15	30
125	3	126	35	33	22	<15	<15	<15	<15	<15	<15	13	38	25	<15	<15	<15	<15	<15	<15	16
	6	252	70	41	36	<15	<15	<15	<15	<15	<15	21	44	39	17	<15	<15	<15	<15	19	36
	9	379	105	45	37	<15	<15	<15	<15	<15	<15	23	49	45	22	<15	<15	<15	<15	22	30
	12	505	140	51	38	18	<15	<15	<15	<15	<15	27	59	49	26	<15	<15	<15	<15	21	36
160	3	209	58	37	27	<15	<15	<15	<15	<15	19	20	42	30	17	<15	<15	<15	<15	19	22
	6	418	116	45	41	23	<15	<15	<15	<15	20	27	48	44	28	<15	<15	<15	17	24	30
	9	627	174	49	42	25	<15	<15	<15	<15	21	28	53	50	33	<15	<15	<15	20	27	35
	12	836	232	55	43	29	<15	<15	<15	<15	21	32	63	54	37	15	<15	<15	21	30	41
200	3	329	91	44	32	17	<15	<15	<15	<15	22	24	49	35	23	<15	<15	<15	15	28	29
	6	658	183	52	46	29	<15	<15	<15	<15	23	32	55	49	34	<15	<15	<15	21	33	37
	9	987	274	56	47	31	<15	<15	<15	<15	24	34	60	55	39	21	<15	<15	24	36	41
	12	1316	366	62	48	35	15	<15	<15	15	24	38	70	59	43	22	<15	<15	25	39	47
250	3	517	144	49	36	23	<15	<15	<15	15	25	28	53	39	29	<15	<15	<15	20	31	33
	6	1034	287	57	50	35	17	<15	<15	18	26	36	59	53	40	22	<15	<15	26	36	41
	9	1552	431	61	51	37	17	<15	<15	18	27	38	64	59	45	29	<15	<15	29	39	45
	12	2069	575	67	52	41	23	<15	<15	20	27	43	74	63	49	30	15	<15	30	42	51
315	3	825	229	52	40	29	<15	<15	<15	21	28	31	54	37	24	<15	<15	<15	19	34	35
	6	1651	459	60	54	41	24	<15	<15	24	30	40	60	51	35	22	<15	19	25	39	41
	9	2476	688	64	55	43	24	<15	<15	24	31	42	65	57	46	30	19	22	33	42	46
	12	3301	917	70	56	47	30	16	16	26	31	46	75	61	44	29	19	23	35	45	51
400	3	1336	371	54	44	34	22	<15	16	26	33	36	61	47	40	28	18	21	31	40	42
	6	2672	742	62	58	46	32	19	19	29	34	44	67	61	51	37	25	27	38	45	50
	9	4009	1114	66	59	48	32	19	20	29	35	46	72	67	56	44	30	31	40	48	54
	12	5345	1485	72	60	52	38	24	23	31	35	50	82	71	60	45	32	32	41	51	60

FLOW GENERATED NOISE -RS-EX L=1450 - PRESSURE LOSS 500 PA/1000 PA

NW	v _k (m/s)	V (m ³ /h) [l/s]			Δp _t = 500 Pa								L _{WA} [dB(A)]	Δp _t = 1000 Pa										
					L _w [dB/oct]											L _w [dB/oct]								
					f _m (Hz)											f _m (Hz)								
					63	125	250	500	1000	2000	4000	8000		63	125	250	500	1000	2000	4000	8000	L _{WA} [dB(A)]		
100	3	80	22	33	26	<15	<15	<15	<15	<15	<15	15	50	33	<15	<15	<15	<15	<15	<15	22	26		
	6	160	44	37	39	<15	<15	<15	<15	<15	18	24	54	39	17	<15	<15	<15	<15	<15	29	32		
	9	239	66	45	47	22	<15	<15	<15	<15	22	31	61	47	24	15	<15	<15	<15	<15	31	37		
	12	319	89	48	49	23	<15	<15	<15	<15	24	33	65	48	27	20	18	17	17	35	35	41		
125	3	126	35	42	30	<15	<15	<15	<15	<15	17	20	53	37	15	<15	<15	<15	<15	<15	26	30		
	6	252	70	46	43	21	<15	<15	<15	<15	22	28	57	43	24	<15	<15	<15	19	33	33	35		
	9	379	105	54	51	29	<15	<15	<15	<15	26	36	64	51	31	17	16	16	22	35	35	41		
	12	505	140	57	53	30	15	<15	<15	17	28	38	68	54	34	22	20	19	26	39	39	44		
160	3	209	58	49	35	21	<15	<15	<15	15	28	29	56	42	26	<15	<15	<15	24	35	35	36		
	6	418	116	53	48	32	<15	<15	<15	21	33	36	60	48	35	17	<15	<15	30	42	42	43		
	9	627	174	61	56	40	18	<15	<15	25	37	42	67	56	42	22	18	19	33	44	44	47		
	12	836	232	64	58	41	20	<15	<15	28	39	45	71	59	45	27	22	22	37	48	48	50		
200	3	329	91	55	40	27	<15	<15	<15	19	31	33	59	47	32	16	<15	<15	28	39	39	40		
	6	658	183	59	53	38	20	<15	<15	25	36	40	63	53	41	24	15	18	34	46	46	47		
	9	987	274	67	61	46	25	<15	<15	29	40	47	70	61	48	29	20	24	37	48	48	51		
	12	1316	366	70	63	47	27	15	16	32	43	50	74	64	51	34	24	27	41	52	52	54		
250	3	517	144	59	44	33	18	<15	<15	24	35	37	62	51	38	24	15	17	33	43	43	44		
	6	1034	287	63	57	44	28	15	17	30	40	45	66	57	47	32	21	23	39	50	50	51		
	9	1552	431	71	65	52	33	19	19	34	44	52	73	65	54	37	26	29	42	52	52	55		
	12	2069	575	74	67	53	35	21	21	37	46	54	77	68	57	42	30	32	46	56	56	58		
315	3	825	229	63	48	39	25	16	20	30	40	42	65	55	44	31	24	28	39	48	48	49		
	6	1651	459	67	61	50	35	24	28	36	45	49	69	61	53	39	30	34	45	55	55	56		
	9	2476	688	75	69	58	40	28	30	40	49	56	76	69	60	44	35	40	48	57	57	60		
	12	3301	917	78	71	59	42	30	32	43	51	58	80	72	63	49	39	43	52	61	61	63		
400	3	1336	371	56	52	44	33	24	27	35	44	45	67	59	49	39	32	35	44	52	52	53		
	6	2672	742	70	65	55	43	32	35	41	49	54	71	65	58	47	38	41	50	59	59	60		
	9	4009	1114	78	73	63	48	36	37	45	53	60	78	73	65	52	43	47	53	62	62	64		
	12	5345	1485	81	75	64	50	38	39	48	55	62	82	76	68	57	47	50	57	66	66	68		

FLOW GENERATED NOISE -RS-EX L=1950 - PRESSURE LOSS 125 PA/250 PA

NW	v _k (m/s)	V (m ³ /h) [l/s]			Δp _t = 125 Pa								Δp _t = 250 Pa													
					L _w [dB/oct]											L _w [dB/oct]										
					f _m (Hz)											f _m (Hz)										
					63	125	250	500	1000	2000	4000	8000	L _{WA} [dB(A)]	63	125	250	500	1000	2000	4000	8000	L _{WA} [dB(A)]				
100	3	80	22	24	<15	<15	<15	<15	<15	<15	1	28	<15	<15	<15	<15	<15	<15	<15	4						
	6	160	44	32	24	<15	<15	<15	<15	<15	10	34	27	<15	<15	<15	<15	<15	<15	13						
	9	239	66	36	25	<15	<15	<15	<15	<15	12	39	33	<15	<15	<15	<15	<15	<15	18						
	12	319	89	42	26	<15	<15	<15	<15	<15	17	49	37	<15	<15	<15	<15	<15	<15	25						
125	3	126	35	32	16	<15	<15	<15	<15	<15	8	37	19	<15	<15	<15	<15	<15	<15	25						
	6	252	70	40	30	<15	<15	<15	<15	<15	17	43	33	<15	<15	<15	<15	<15	<15	32						
	9	379	105	44	31	<15	<15	<15	<15	<15	20	48	39	<15	<15	<15	<15	<15	<15	37						
	12	505	140	50	32	<15	<15	<15	<15	<15	24	58	43	15	<15	<15	<15	<15	<15	44						
160	3	209	58	35	21	<15	<15	<15	<15	<15	14	40	24	<15	<15	<15	<15	<15	<15	16						
	6	418	116	43	35	<15	<15	<15	<15	<15	21	46	38	19	<15	<15	<15	<15	17	25						
	9	627	174	47	36	16	<15	<15	<15	<15	24	51	44	24	<15	<15	<15	<15	20	30						
	12	836	232	53	37	20	<15	<15	<15	<15	28	61	48	28	<15	<15	<15	<15	23	37						
200	3	329	91	42	27	<15	<15	<15	<15	17	20	47	30	15	<15	<15	<15	<15	23	25						
	6	658	183	50	41	21	<15	<15	<15	18	28	53	44	26	<15	<15	<15	<15	28	32						
	9	987	274	54	42	23	<15	<15	<15	19	30	58	50	31	<15	<15	<15	15	31	37						
	12	1316	366	60	43	27	<15	<15	<15	19	35	68	54	35	<15	<15	<15	16	34	44						
250	3	517	144	47	32	16	<15	<15	<15	21	24	51	35	22	<15	<15	<15	<15	27	29						
	6	1034	287	55	46	28	<15	<15	<15	22	33	57	49	33	<15	<15	<15	18	32	37						
	9	1552	431	59	47	30	<15	<15	<15	23	35	62	55	38	17	<15	<15	21	35	42						
	12	2069	575	65	48	34	<15	<15	<15	23	40	72	59	42	18	<15	<15	22	38	48						
315	3	825	229	50	36	23	<15	<15	<15	25	28	52	33	18	<15	<15	<15	<15	31	32						
	6	1651	459	58	50	35	16	<15	<15	17	27	37	58	47	29	<15	<15	<15	18	36	38					
	9	2476	688	62	51	37	16	<15	<15	17	28	39	63	53	40	22	<15	17	26	39	42					
	12	3301	917	68	52	41	22	<15	<15	19	28	43	73	57	38	21	<15	18	28	42	49					
400	3	1336	371	52	41	29	<15	<15	<15	20	30	32	59	44	35	20	<15	17	25	37	39					
	6	2672	742	60	55	41	24	<15	15	23	31	41	65	58	46	29	15	23	31	42	46					
	9	4009	1114	64	56	43	24	<15	16	23	32	43	70	64	51	36	20	27	34	45	51					
	12	5345	1485	70	57	47	30	<15	19	25	32	46	80	68	55	37	22	28	35	48	57					

FLOW GENERATED NOISE -RS-EX L=1950 - PRESSURE LOSS 500 PA/1000 PA

NW	v _k (m/s)	V (m ³ /h) [l/s]			Δp _t = 500 Pa								L _{WA} [dB(A)]	Δp _t = 1000 Pa										
					L _w [dB/oct]											L _w [dB/oct]								
					f _m (Hz)											f _m (Hz)								
					63	125	250	500	1000	2000	4000	8000		63	125	250	500	1000	2000	4000	8000			
100	3	80	22	32	18	<15	<15	<15	<15	<15	<15	9	49	25	<15	<15	<15	<15	<15	<15	23			
	6	160	44	36	31	<15	<15	<15	<15	<15	<15	17	53	31	<15	<15	<15	<15	<15	19	28			
	9	239	66	44	39	16	<15	<15	<15	<15	<15	24	60	39	18	15	<15	<15	<15	21	34			
	12	319	89	47	41	17	<15	<15	<15	<15	<15	27	64	40	21	20	18	27	<15	25	38			
125	3	126	35	32	18	<15	<15	<15	<15	<15	<15	9	49	25	<15	<15	<15	<15	<15	<15	23			
	6	252	70	36	31	<15	<15	<15	<15	<15	<15	17	53	31	<15	<15	<15	<15	<15	19	28			
	9	379	105	44	39	16	<15	<15	<15	<15	<15	24	60	39	18	15	<15	<15	<15	21	34			
	12	505	140	47	41	17	<15	<15	<15	<15	<15	27	64	40	21	20	18	27	<15	25	38			
160	3	209	58	47	29	<15	<15	<15	<15	<15	21	24	54	36	17	<15	<15	<15	<15	28	31			
	6	418	116	51	42	23	<15	<15	<15	<15	26	30	58	42	26	<15	<15	<15	19	35	37			
	9	627	174	59	50	31	15	<15	<15	<15	30	37	65	50	33	19	18	18	22	37	42			
	12	836	232	62	52	32	17	<15	<15	17	32	39	69	53	36	24	22	21	26	41	45			
200	3	329	91	53	35	19	<15	<15	<15	<15	26	29	57	42	24	<15	<15	<15	19	34	36			
	6	658	183	57	48	30	<15	<15	<15	16	31	36	61	48	33	16	15	<15	25	41	42			
	9	987	274	65	56	38	17	<15	<15	20	35	43	68	56	40	21	20	20	28	43	46			
	12	1316	366	68	58	39	19	15	<15	23	38	45	72	59	43	26	24	23	32	47	50			
250	3	517	144	57	40	26	<15	<15	<15	16	31	34	60	47	31	<15	<15	<15	25	39	40			
	6	1034	287	61	53	37	16	<15	<15	22	36	41	64	53	40	20	17	17	31	46	46			
	9	1552	431	69	61	45	21	15	<15	26	40	48	71	61	47	25	22	23	34	48	51			
	12	2069	575	72	63	46	23	17	15	29	42	50	75	64	50	30	26	26	38	52	54			
315	3	825	229	61	44	33	17	<15	15	23	37	39	63	51	38	23	<15	23	32	45	45			
	6	1651	459	65	57	44	27	<15	23	29	42	46	57	57	47	31	19	29	38	52	52			
	9	2476	688	73	65	52	32	17	25	33	46	52	74	65	54	36	27	35	41	54	56			
	12	3301	917	76	67	53	34	19	27	36	48	55	78	68	57	41	28	38	45	58	60			
400	3	1336	371	54	49	39	25	<15	23	29	41	42	65	56	44	31	22	31	38	49	50			
	6	2672	742	68	62	50	35	22	31	35	46	50	69	62	53	39	28	37	44	56	56			
	9	4009	1114	76	70	58	40	26	33	39	50	57	76	70	60	44	33	43	47	59	61			
	12	5345	1485	79	72	59	42	28	35	42	52	59	80	73	63	49	37	46	51	63	64			

CONNECTION DIAGRAM OF ATEX UNIT

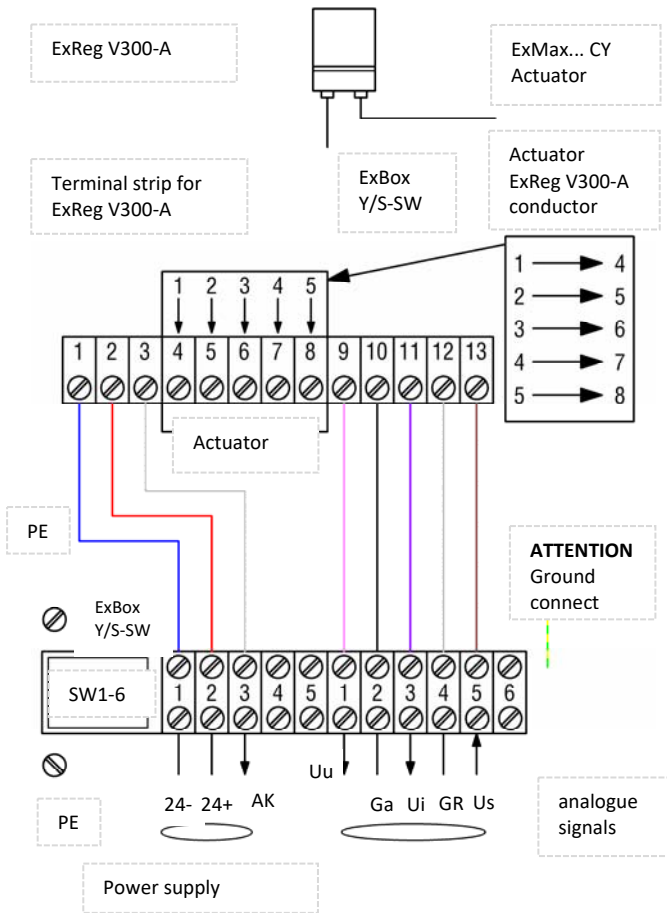

Connection diagram of terminal box

left: 1 to 5	right: 1 to 6
1 to 1 = blue	9 to 1 = pink
2 to 2 = red	10 to 2 = black
3 to 3 = white	11 to 3 = purple
	12 to 4 = grey
	13 to 5 = brown

CONNECTION DIAGRAM OF ATEX CONTROLLER

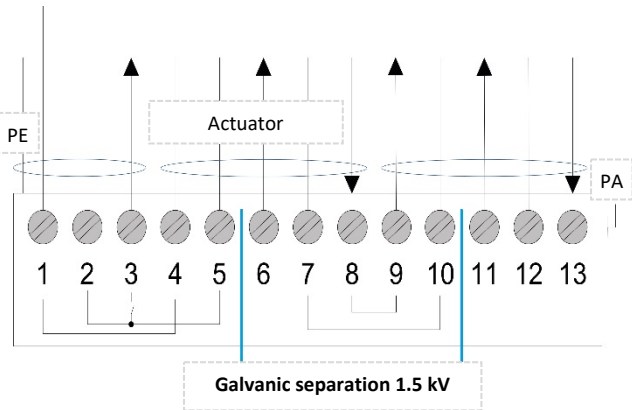

Connection assignment of ATEX controller V300-A

1 = 24 V AC / DC (-)
2 = 24 V AC / DC (+)
3 = AK - alarm contact
4 = 24 V AC / DC (-) power supply actuator
5 = 24 V AC / DC (+) power supply actuator
6 = U_i - Setpoint value of the actuator 4... 20mA
7 = G_a - Ground Y, Gd
8 = U_u = actual value of actuator 0...10 V
9 = U_u - damper position 0...10 V
10 = G_a : ground drive, GND
11 = U_i = actual value of controller 0/2...10 V
12 = G_r - Ground of the controller, GND
13 = U_s - Setpoint value of the controller 0/2...10 V

Connection of Schischek ExReg-V300-A

ExReg-V300-A is the standard version for controlling variable volumetric flows (VAV). The alarm contact (terminal 3) serves to provide feedback for normal operation. Moreover, the device has an analogue output (terminal 11) which emits the current setpoint value as a continuous signal and an analogue feedback of the damper position (terminal 9). This function is mainly used for saving energy.

A setpoint value is specified via terminal 13. The voltage for the minimal and maximal volumetric flow is defined either in the range of 0 to 10 V or in the range of 2 to 10 V. Depending on the settings applied in menu 6 (setpoint value), the function of positive control may be used additionally. If the voltage value exceeds approximately 12 V, the damper leaf opens. In case the voltage value falls below 0.2 V, the damper leaf will be completely closed. During this positive control function (damper OPEN / CLOSED), the control remains inoperable. If the input is not connected, the value set in menu 7.2 (default) will be used as constant volumetric flow.

Controllers of type V300 and V300-B can be provided upon request as well.

PRIOR TO MOUNTING AND COMMISSIONING



An instruction leaflet containing information on safety, transport disposal, installation, commissioning and maintenance is enclosed with each SCHAKO product. For safety reasons, this instruction leaflet must be read under all circumstances and completely adhered to.

Marking

The product has the following ATEX marking:



II 2G Ex h IIC T6 Gb EPS 11 ATEX 2 307 X
II 2D Ex h IIIC T80°C Db

The devices have been designed for use in areas subject to explosion hazards according to ATEX of device group 2, device category 2 for Zones 1 and 21, as well as device category 3 for Zones 2 and 22.

These devices are NOT suitable for use in non-approved Ex zones. The operating safety of the devices is only guaranteed when used in accordance with their designated use. According to the ATEX marking, the volumetric flow controller may only be used for media with a maximum temperature of up to 80 °C.

Special operation

It must be ensured that all metallic parts and conductive plastics are properly and permanently connected to earth potential.

The attached and installed electrical devices must have a suitable explosion-proof design. The combination of electrical and non-electrical devices must be examined again from a safety point of view.

To avoid propagating brush discharges in housings with RAL coating, it must be ensured that the air in the ventilation system is not heavily contaminated with non-conductive particles.

Type of ignition protection

The type of ignition protection of the volumetric flow controller is guaranteed by its safe design.

Quality

The SCHAKO production facilities are certified according to the QM procedure EN ISO 9001.

Zero point adjustment of the static pressure sensor

(see also SCHISCHEK documentation Ex-Reg)

For Schischek ExReg-V300-A controller, a zero adjustment must be performed for commissioning in order to correct mounting position-dependent measurement deviations. For this purpose, the pressure connections P+ and P- are to be short-circuited mechanically and the adjustment should be carried out according to menu 3.2. [0-point]. In order to achieve a constant operating temperature, the controller should be connected to the supply voltage about 15 minutes before the zero adjustment begins.

Disposal

The devices have been prepared in accordance with the RoHS directive restricting the use of certain hazardous substances in electrical and electronic equipment (2002/95/EC). After its final decommissioning, the volumetric flow controller must be properly disposed of.

INSTALLATION INFORMATION

To avoid unnecessary controller errors, the min. distances according to the following table / drawings must be observed. For combinations of several connection pieces or pieces with fire dampers or silencers, the larger minimum distances must be observed. All volumetric flow controllers can be assembled with horizontal or vertical damper axis.

Distance to a bend

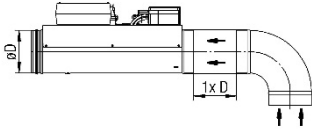

Distance downstream of other connecting pieces

(e.g. branching piece, reducing piece, T-junction, etc.)

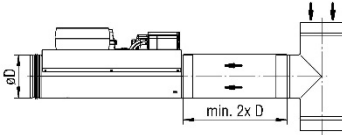

Distance to a fire damper

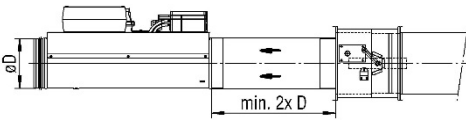

Distance to a silencer with intermediate baffle

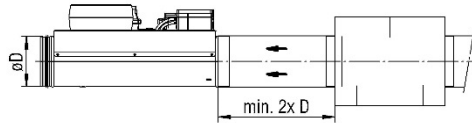

Distances

Distance to	VREX
Bend	1 x D
other connection pieces (e.g. T-junction, branching piece, reducing piece, etc.)	2 x D
Fire damper	2 x D
Silencer	2 x D

MAINTENANCE AND SERVICE

Assembly and maintenance instructions

1. The controllers must be assembled in a way to allow inspection at any time.
2. For volumetric flow controllers with integrated controller with static membrane pressure sensor, it is imperative to observe the notice sign regarding its mounting position. The volumetric flow controllers are not suitable for air containing sticky and greasy components.
3. The volumetric flow controller must not be carried on the regulation components, measuring cross or the damper blade, but only on the housing.
4. The controllers must be carefully stored on-site. They must be protected from dust, dirt and from direct weather effects.
5. Assembly must be carried out by expert personnel, observing recognised technical rules and regulations.
6. The controller and all electric components have to be connected to equipotential bonding at any time.

LEGEND

D_e	[dB/Okt]	=	Insertion loss
E_K	(m/s)	=	Calibration curve
F	(m ²)	=	Inflow area
f_m	(Hz)	=	Octave band centre frequency
K_F	(-)	=	Correction factor
$L_{W\text{ abst}}$	[dB/Okt]	=	Radiated noise / octave
L_W	[dB/oct]	=	Sound power level/ octave ($L_W = L_{W1} + K_F$)
L_{W1}	[dB/oct]	=	Sound power level / octave, relative to 1 m ² of inflow area
L_{WA}	[dB(A)]	=	A-weighted sound power level ($L_{WA} = L_{WA1} + K_F$)
L_{WA1}	[dB(A)]	=	A-weighted sound power level in duct, relative to 1 m ² of inflow area
NW	(mm)	=	Nominal width
U_5	(V) DC	=	Measurement output (electric voltage)
V	(m ³ /h)	=	Air volume
\dot{V}	[l/s]	=	Air volume
V_{\min}	(m ³ /h)	=	Minimum volumetric flow
V_{kon}	(m ³ /h)	=	Constant volumetric flow
V_{\max}	(m ³ /h)	=	Maximum volumetric flow
v_K	(m/s)	=	Duct velocity
ΔL_W	[dB/Okt]	=	Level correction value / octave
$\Delta p_{t\text{ min}}$	(Pa)	=	Minimum static pressure difference
Δp_t	(Pa)	=	Pressure loss
Δp_w	(Pa)	=	Differential pressure
ρ	(kg/m ³)	=	Density

CALCULATION FORMULAE

Calculation of the nominal volumetric flow

$$V_{\text{nenn}} = E_K \times F \times 3600$$

Setting values for V_{\min}

The required volumetric flow that is to flow at the 0 V DC command signal (operating mode 0-10 V DC) or at the 2 V DC command signal (operating mode 2 - 10 V DC) at terminal 13 (U_5 or in terminal box terminal 5) or with positive control V_{\min} is set in m³/h at the controller.

This value refers to the set V_{nenn} volumetric flow.

Formula

$$EW_{V_{\min}} = V_{\min} / V_{\text{nenn}} \times 100 \text{ percent}$$

Setting values for V_{\max}

The required volumetric flow that is to flow at the 10 V DC command signal at terminal 13 (U_5 or terminal box terminal 5) or with positive control V_{\max} is set in m³/h at the controller. This value refers to the set V_{nenn} nominal volumetric flow.

Formula

$$EW_{V_{\max}} = V_{\max} / V_{\text{nenn}} \times 100 \text{ percent}$$

ORDER CODE

01	02	03	04	05	06	07	08	09
Type	Size	Material	Attachment assembly	Mode	Volumetric flow V_{min}	Volumetric flow V_{max}	Duct connection	Acoustic cladding
Example								
VREX	-200	-SV	-A100	-2	-0600	-1200	-KA0	-FD1

10
Damper position
-NC

SAMPLE

VREX-200-SV-A100-2-0600-1200-KA0-FD1-NC

Volumetric flow controller in round design I NW200 I galvanised sheet steel I with attachment assembly ATEX-NM-F-K2 and spring return actuator I Mode 2-10 V I $V_{min}=600 \text{ m}^3/\text{h}$ I $V_{max}=1200 \text{ m}^3/\text{h}$ I without rubber lip seal or flange I with flat-bed acoustic cladding I with damper position, currentless CLOSED

ORDER DETAILS

01 - Type

VREX = Volumetric flow controller, round design, made of galvanized sheet steel, model ATEX

02 - Nominal size

100 = NW 100 mm
 125 = NW 125 mm
 160 = NW 160 mm
 200 = NW 200 mm
 250 = NW 250 mm
 315 = NW 315 mm
 400 = NW 400 mm

03 - Material

SV = Galvanised sheet steel (standard)
 V2 = Stainless steel V2A, 1.4301
 V4 = Stainless steel V4A, 1.4571
 DD = DD-coating on the inside with galvanised sheet steel

04 - Attachment assembly

A098 = ATEX-NM-K2 (standard)
 A100 = ATEX-NM-F-K2

05 - Mode

0 = 0-10 V
 2 = 2-10 V (standard)

06 - Volumetric flow set value V_{min}/V_{kon}

0000 = ex works, see table p.5
 xxxx = 4-digit value in m^3/h according to customer specification

07 - Volumetric flow set value V_{max}

0000 = ex works, see table p.5
 xxxx = 4-digit value in m^3/h according to customer specification

08 - Duct connection

KA0 = without rubber lip seal/without flange (standard)
 GD1 = with rubber lip seal
 FF1 = flat flange, galvanised steel
 FF2 = flat flange, V2A 1.4301
 MF1 = METU flange, galvanised steel
 MF2 = METU flange, V2A 1.4301

Please note!

Tension rings, counter flanges or duct silencers must be ordered separately and are supplied loose!

09 - Acoustic cladding

DS0 = without acoustic cladding (standard)
 DS2 = Acoustic cladding with 20 mm
 FD1 = Flat-bed acoustic cladding

10 - Damper position

NA = no spring return actuator (standard)
 NO = currentless OPEN - normally open (only for actuators with spring return)
 NC = currentless CLOSED - normally closed (only for actuators with spring return)

SPECIFICATION TEXT

VREX

Volumetric flow controller made of galvanised sheet steel in round design, for spiral duct connection, for use in supply and return air systems for constant or variable volumetric flow regulation. Suitable for room or duct pressure control. ATEX version available in accordance with product directive ATEX 2014/34/EU.

Allowed differential pressure range: 0-1000 Pa.

Allowed ambient temperature 0...50°C.

For use with duct velocities of 2-13 m/s.

It is possible to subsequently adjust the manufacturer set operation volume flow.

The output signals 0/2...10 V DC can be used for actual value display and for display of the damper position.

Housing made of galvanised sheet steel with damper blade seal free of silicone made of PUR for airtight sealing to DIN EN 1751 (Class 2 NW 100 only, Class 3 NW 125 - 400 only), **housing leakage class B** according to DIN EN 1751.

Aluminium measuring rods in which for measuring the average values 6 measuring points each have been attached to the pressure and suction sides, using the median line method.

Damper bearing made of brass

With electric controller, with integrated precision pressure sensor for differential pressure measurement.

Supply voltage: 24 V AC/DC ± 15% (20.4...27.6 VAC/DC), 50/60 Hz

wiring and adjusting by manufacturer.

Product: SCHAKO type VREX

- with spring return actuator (at an extra charge)
 - currentless CLOSED
 - currentless OPEN
- Housing (at an extra charge) made of:
 - Galvanised sheet steel, with DD coating (-DD)
 - Stainless steel 1.4301 (-V2A)
 - Stainless steel 1.4571 (-V4A)

Accessories for VREX

Metu flange (-MF1, MF2)

- on both sides, duct flange type MF1, galvanised steel
- on both sides, duct flange type MF2, stainless steel V2A, 1.4301

Counter flange (-GF) (pair), loose

- on both sides, to Metu flange (must be ordered separately)

Tension ring (-SR) (pair), loose

- to connect Metu flange to counter flange (must be ordered separately)

Construction subject to change
 No return possible

Flat flange (-FF1, FF2)

- on both sides, according to DIN 24 154/5. type FF1, galvanised steel
- on both sides, according to DIN 24 154/5. type FF2, stainless steel V2A, 1.4301

Acoustic cladding (-DS 2)

- made of sound-absorbing, insulating 20 mm material with sheet steel covering made of galvanised sheet steel, non-flammable according to DIN 4102-17.

Flat-bed acoustic cladding (-FD1)

- made of sound-absorbing, insulating 3 mm material with sheet steel covering made of galvanised sheet steel (standard)

Rubber lip seal (-GD1)

- on both sides, special rubber.



Duct silencer (-RS-Ex)

- rigid model
- Outer jacket and perforated plate made of galvanised sheet steel
- mineral wool filling

Please note!

Counter flanges, tension rings or duct silencers must be ordered separately and are supplied loose!

TYPE PLATE

	
Volumenstromregler Typ: VREX	
Baugröße
Baujahr
Auftragsnummer
Positionsnummer
Seriennummer
 II 2G Ex h IIC T6 Gb II 2D Ex h IIIC T80°C Db	
EPS 11 ATEX 2 307X	

CERTIFICATE OF CONFORMITY





Konformitätsbescheinigung

- (1)
- (2) Geräte und Schutzsysteme zur bestimmungsgemäßen Verwendung in explosionsgefährdeten Bereichen – **Richtlinie 2014/34/EU**
- (3) Bescheinigungsnummer

EPS 11 ATEX 2 307 X **Revision 3**
- (4) Gerät: Volumenstromregler Typ: VRA, VREX, VQEX und VPEX
- (5) Hersteller: Schako KG
- (6) Anschrift: Steigstraße 25-27
78600 Kolbingen
Deutschland
- (7) Die Bauart dieses Gerätes sowie die verschiedenen zulässigen Ausführungen sind in der Anlage zu dieser Konformitätsbescheinigung festgelegt.
- (8) Bureau Veritas Consumer Products Services Germany GmbH bescheinigt aufgrund einer freiwilligen Prüfung auf Basis der Richtlinie 2014/34/EU des Europäischen Parlaments und des Rates vom 26. Februar 2014 die Erfüllung der grundlegenden Sicherheits- und Gesundheitsanforderungen für die Konzeption und den Bau von Geräten und Schutzsystemen zur bestimmungsgemäßen Verwendung in explosionsgefährdeten Bereichen gemäß Anhang II der Richtlinie. Die Ergebnisse der Prüfung sind in der vertraulichen Dokumentation unter der Referenznummer 10TH0561 festgelegt.
- (9) Die grundlegenden Sicherheits- und Gesundheitsanforderungen werden erfüllt durch Übereinstimmung mit:

EN ISO 80079-36:2016 **EN ISO 80079-37:2016**
- (10) Falls das Zeichen „X“ hinter der Bescheinigungsnummer steht, wird auf besondere Bedingungen für die sichere Anwendung des Gerätes in der Anlage zu dieser Bescheinigung hingewiesen.
- (11) Diese Konformitätsbescheinigung bezieht sich nur auf Konzeption und Prüfung des festgelegten Gerätes gemäß Richtlinie 2014/34/EU. Weitere Anforderungen dieser Richtlinie gelten für die Herstellung und das Inverkehrbringen dieses Gerätes. Diese Anforderungen werden nicht durch diese Bescheinigung abgedeckt.
- (12) Die Kennzeichnung des Gerätes muss die folgenden Angaben enthalten:

 II 2G Ex h IIC T6 Gb
 II 2D Ex h IIIC T80°C Db



Hamburg, 15.05.2020

Seite 1 von 2

Bescheinigungen ohne Unterschrift und Siegel haben keine Gültigkeit. Diese Bescheinigung darf nur unverändert weiterverbreitet werden. Auszüge oder Änderungen bedürfen der Genehmigung von Bureau Veritas Consumer Products Services Germany GmbH. EPS 11 ATEX 2 307 X, Revision 3.



(13)

Anlage

(14) **Konformitätsbescheinigung EPS 11 ATEX 2 307 X****Revision 3**(15) Beschreibung des Gerätes:

Die Volumenstromregler werden zur druckunabhängigen Regelung von Volumenströmen in Lüftungs- und Klimaanlage eingesetzt. Der Antrieb erfolgt durch zugelassene elektrische oder pneumatische Stellantriebe (Systeme). Die Messung des Volumenstroms erfolgt mittels eines Doppelmesskreuzes und kann extern durch ein zugelassenes System ausgewertet werden.

(16) Referenznummer: 10TH0561(17) Besondere Bedingungen:

Es muss sichergestellt werden, dass alle metallischen Teile sowie die leitfähigen Kunststoffe ordnungsgemäß und dauerhaft mit dem Erdpotential verbunden sind.

Die an- und eingebauten elektrischen Geräte müssen in geeigneter Weise explosionsgeschützt ausgeführt sein. Die Zusammenführung von elektrischen und nichtelektrischen Geräten muss erneut sicherheitstechnisch betrachtet werden.

Zur Vermeidung von Gleitstielbüschelentladungen muss bei den Gehäusen mit RAL Lack sichergestellt werden, dass die Luft im Lüftungssystem keine starke Belastung an nichtleitfähigen Partikeln aufweist.

(18) Grundlegende Sicherheits- und Gesundheitsanforderungen:

Durch **Übereinstimmung mit Normen abgedeckt.**

Zertifizierungsstelle Explosionsschutz



Hamburg, 15.05.2020

Seite 2 von 2

Bescheinigungen ohne Unterschrift und Siegel haben keine Gültigkeit. Diese Bescheinigung darf nur unverändert weiterverbreitet werden. Auszüge oder Änderungen bedürfen der Genehmigung von Bureau Veritas Consumer Products Services Germany GmbH. EPS 11 ATEX 2 307 X, Revision 3.