

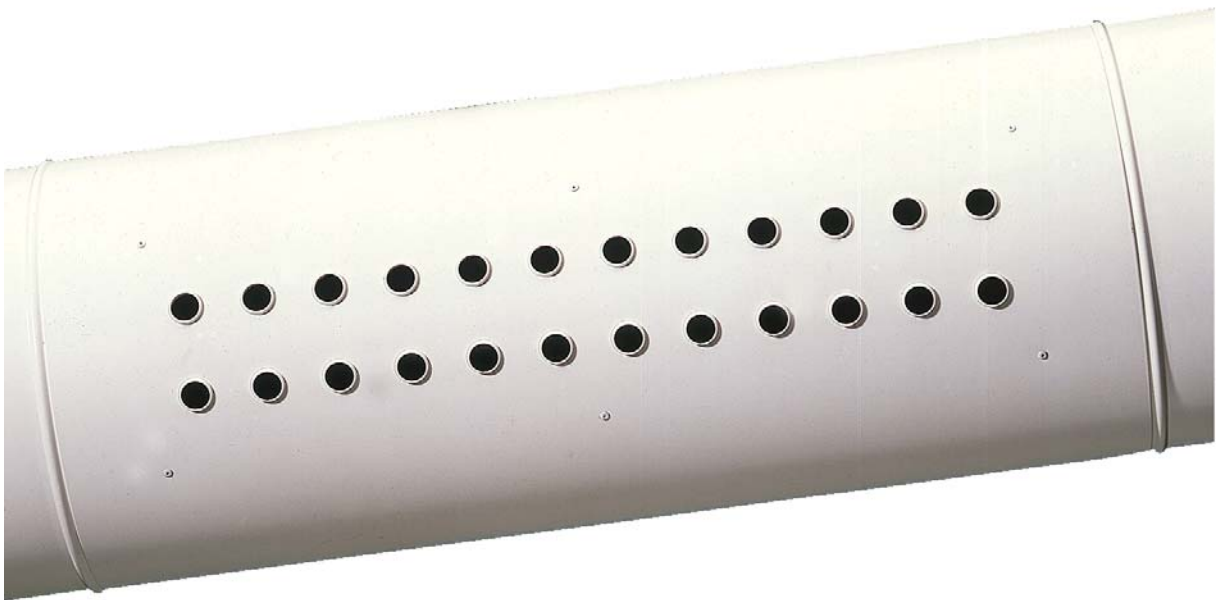

Round duct nozzle jet diffuser DSARR



SCHAKO KG
Steigstraße 25-27
D-78600 Kolbingen
Telephone +49 (0) 74 63 - 980 - 0
Fax +49 (0) 74 63 - 980 - 200
info@schako.de
schako.com

Round Duct Nozzle Jet Diffuser Type DSARR

Contents

Description	3
Construction	3
Model	3
Accessories	3
Fastening methods	3
Mounting position	3
Models and dimensions	4
Dimensions	4
Division of length	5
Accessories	5
Fastening methods	5
Order code DSARR	6
Specification texts	7

Round Duct Nozzle Jet Diffuser Type DSARR

Description

In modern architecture, sheet metal and spiral ducts of air-conditioning systems are often incorporated in the design of the room. Emphasis is often placed deliberately on parts of the supply system. In this visible installation of the ventilation ducts, it is a good idea to integrate the air diffusers into the ducts.

The round duct nozzle jet diffuser type DSARR is suitable for installation in supply air systems. The integrated nozzles of the DSARR-F version are not adjustable, those of the DSARR-V version are adjustable manually and individually.

During the installation, the round duct nozzle jet diffuser must be mounted in accordance with the desired air flow direction. The nozzles and the hit-and-miss damper are positioned on the round duct at 3 o'clock (-3U), 6 o'clock (-6U, standard), 9 o'clock (-9U) or 12 o'clock (0U).

A hit-and-miss damper, which ensures that the supply air is blown uniformly across the whole diffuser area, can be integrated into the diffuser. Because of the uniform admission, the round duct nozzle jet diffuser type DSARR can be integrated at any point along the duct system.

Accessories, such as dummy pipes, end covers and connection sleeves complete the range for this diffuser (only available for up to NW500; see documentation for round duct system RR-Complete or round duct systems accessories).

Layout

The round duct nozzle jet diffuser type DSARR is designed on the basis of the diagrams of the nozzle jet diffuser type DSA.

Construction

Round duct

- Galvanised sheet steel (-SV-0000).
- Sheet steel painted to RAL colour 9010 (white, standard) (-SB-9010).
- Sheet steel painted to a freely selectable RAL colour (-SB-xxxx) (colour always with 4 digits).

nozzles

- plastic
- similar to RAL colour 9010 (white) (-DW).
- similar to RAL colour 9005 (black, standard) (-DS).

Model

- | | |
|------------------|--|
| DSARR-F-... | - with fixed nozzles (standard). |
| DSARR-V-... | - with individually and manually adjustable nozzles. |
| DSARR-...-3U-... | - horizontal throw to the right (3 o'clock). |
| DSARR-...-6U-... | - vertical throw downward (6 o'clock) (standard). |
| DSARR-...-9U-... | - horizontal throw to the left (9 o'clock). |
| DSARR-...-0U-... | - vertical throw upward (12 o'clock). |
| DSARR-...-1 | - One row of nozzles (standard). |
| DSARR-...-2 | - Two rows of nozzles. |
| DSARR-...-4 | - Four rows of nozzles (available from NW400). |

Accessories

Hit-and-miss damper

- without hit-and-miss damper (-SN, standard).
- With integrated hit-and-miss damper (-SS) for simple air volume and ductwork regulation, made of the same material as the round duct.

Rubber lip seal

- without rubber lip seal (-GD0) (standard).
- with rubber lip seal (-GD1), on both sides, made of EPDM

For more accessories, please refer to the separate documentation "Round duct system accessories".

Fastening methods

fastening hole

- without fastening hole (-B0).
- with fastening hole $\varnothing 11.5$ mm (-BB, standard). Prepared for suspended installation by using an M8 threaded rod and an M8 nut to be provided on site.

Mounting position

6 o'clock (-6U, standard)

12 o'clock (-0U)

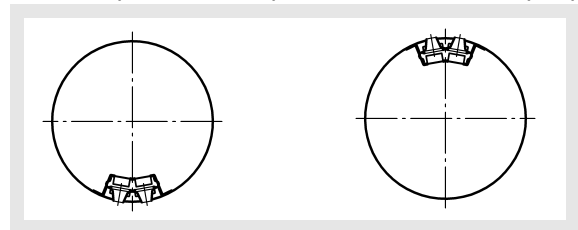

3 o'clock (-3U)

9 o'clock (-9U)

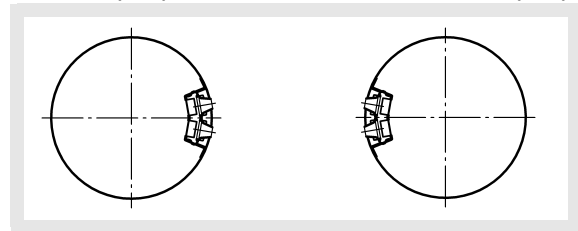

Ex works, the nozzles are set to the 6 o'clock position. On request the position "3 o'clock", "9 o'clock" or "12 o'clock", each in the air flow direction, is also available.

Please note that for the vertical throw a distance of at least 100 mm is necessary between the weld seam and the diffuser. This means that the weld seam must be offset accordingly.

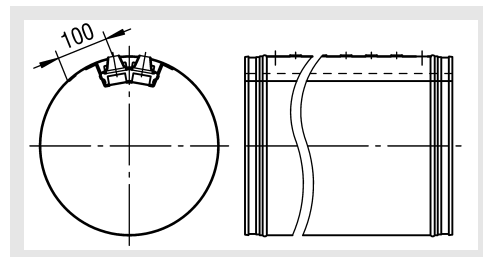

Round Duct Nozzle Jet Diffuser Type DSARR

Models and dimensions

Dimensions

DSA-RR-F-6U-...

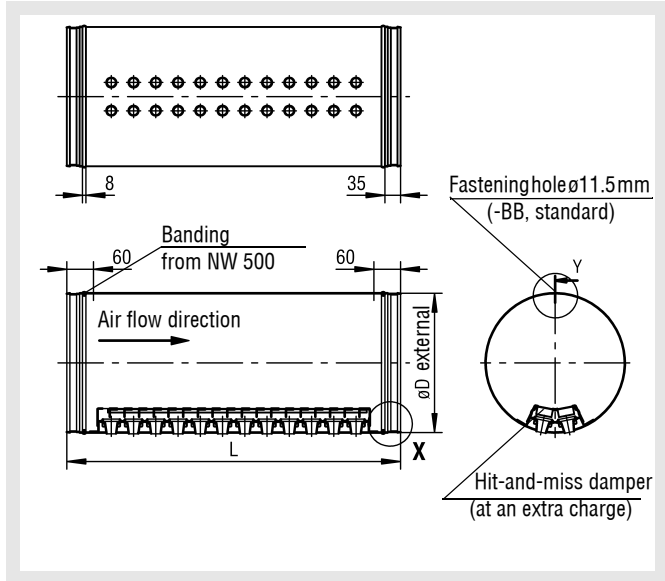

Available sizes

NW	øD	Nozzle rows		
		1	2	4
200	198	X	X	-
224	222	X	X	-
250	248	X	X	-
280	278	X	X	-
315	313	X	X	-
355	353	X	X	-
400	398	X	X	X
450	448	X	X	X
500	498	X	X	X
560	558	X	X	X
630	628	X	X	X

	Length L	Number of nozzles / rows
	1-part	500
750		12
1000		16
2-part	1500	2x12
	1750	1x12 + 1x16
	2000	2x16

X = available
- = not available

All combined lengths and nominal widths available!
Accessories only available for up to NW500 (see documents for round duct system RR-COMPLETE or accessories for round duct systems).

DSA-RR-V-6U-...

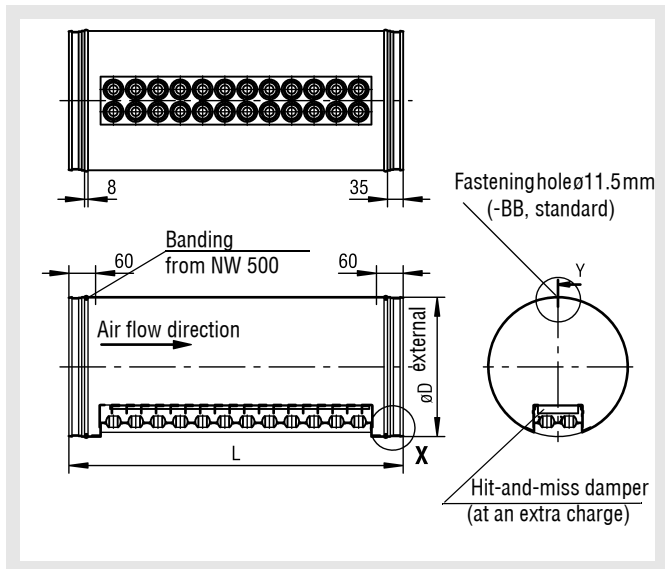

Round Duct Nozzle Jet Diffuser Type DSARR

Division of length

1-part:

Length 500

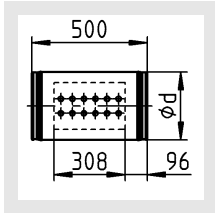

Length 750

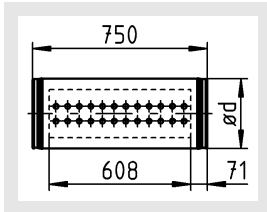

Length 1000

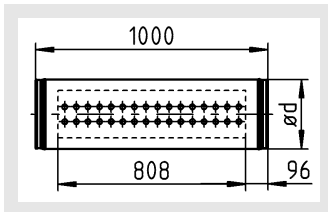

2-part:

Length 1500

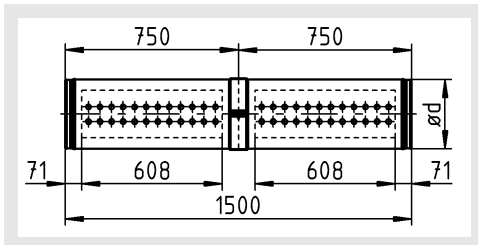

Length 1750

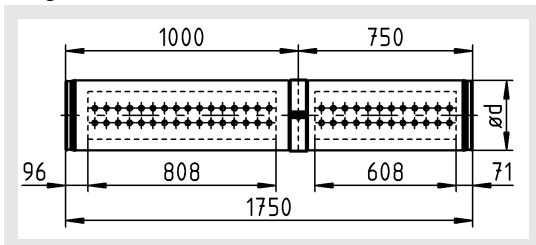

Length 2000

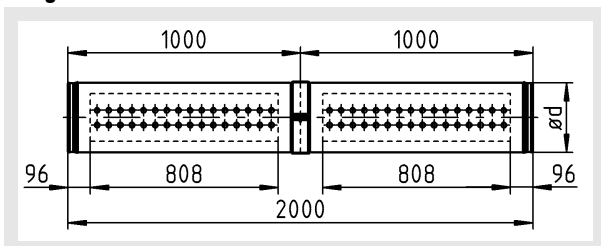

Round duct diffusers with a length of > 1000 mm are produced in two parts and joined in-factory with a connection sleeve.

The dimensions of the dummy pipe fit the dimensions of the round duct grille type DSARR.

A different division of length is possible on special request. However, the maximum length for a middle or end piece is 1000 mm.

Accessories

Rubber lip seal (-GD0 / -GD1)

- without rubber lip seal (-GD0) (standard).
- with rubber lip seal (-GD1), on both sides, made of EPDM.

Detail X

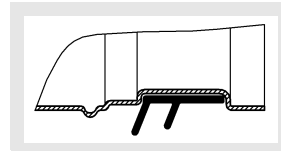

Fastening methods

Fastening hole (-B0 / -BB)

- without fastening hole (-B0).
- with fastening hole $\varnothing 11.5$ mm (-BB).

Suspension on site

Detail Y

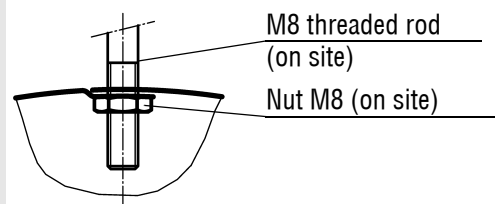

Prepared for suspended installation by using an M8 threaded rod and an M8 nut to be provided by the customer.

Round Duct Nozzle Jet Diffuser Type DSARR

Order code DSARR

01	02	03	04	05	06
Type	Model	Nominal width	Length	Material	Paint
Example					
DSARR	-F	200	-1000	-SB	-9010

07	08	09	10	11	12
Nozzle colour	Nozzle row	Mounting position	Hit-and-miss damper	Rubber lip seal	Fastening methods
-DS	-1	-6U	-SN	-GD0	-BB

Sample

DSARR-F-200-1000-SB-9010-DS-1-6U-SN-GD0-BB

Round duct nozzle jet diffuser type DSARR | With fixed nozzles | Nominal width 200 mm | Length 1000 mm | Sheet steel | Painted to RAL colour 9010 | Plastic nozzles painted in black similar to RAL 9005 | One row | Mounting position 6 o'clock | Without hit-and-miss damper | Without rubber lip seal | With fastening hole

Order details

01 - Type

DSARR = Round Duct Nozzle Jet Diffuser DSARR

02 - Model

F = with fixed nozzles (standard).

V = with individually and manually adjustable nozzles.

03 - Nominal width

200 = 200 mm

224 = 224 mm

250 = 250 mm

280 = 280 mm

315 = 315 mm

355 = 355 mm

400 = 400 mm

450 = 450 mm

500 = 500 mm

560 = 560 mm

630 = 630 mm

04 - Length

0500 = 500 mm (1-part).

0750 = 750 mm (1-part).

1000 = 1000 mm (1-part).

1500 = 1500 mm (2-part).

1750 = 1750 mm (2-part).

2000 = 2000 mm (2-part).

05 - Material

SB = Sheet steel (standard with paint).

SV = Galvanised sheet steel

06 - Paint

0000 = Without paint.

9010 = painted to RAL colour 9010 (white, standard).

xxxx = painted to a freely selectable RAL colour (always with 4 digits).

07 - Nozzle colour

DS = Plastic similar to RAL colour 9005 (black, standard).

DW = Plastic similar to RAL colour 9010 (white).

08 - Nozzle row

1 = One row of nozzles (standard).

2 = Two rows of nozzles.

4 = Four rows of nozzles (available from NW400).

09 - Mounting position

3U = 3 o'clock.

6U = 6 o'clock (standard).

9U = 9 o'clock.

0U = 12 o'clock.

10 - Hit-and-miss damper

SN = without hit-and-miss damper (standard).

SS = with hit-and-miss damper.

11 - Rubber lip seal

GD0 = without rubber lip seal (standard).

GD1 = with rubber lip seal.

12 - Fastening methods

B0 = without fastening hole.

BB = with fastening hole \varnothing 11.5 mm (standard).

Round Duct Nozzle Jet Diffuser Type DSARR

Specification texts

Round duct nozzle jet diffuser for supply air, suitable for connection to DIN ducts.

- With fixed nozzles
Product: SCHAKO type **DSARR-F-...**

- With individually manually adjustable nozzles.
Product: SCHAKO type **DSARR-V-...**

- Nominal width:
 - 200 mm (-200)
 - 224 mm (-224)
 - 250 mm (-250)
 - 280 mm (-280)
 - 315 mm (-315)
 - 355 mm (-355)
 - 400 mm (-400)
 - 450 mm (-450)
 - 500 mm (-500)
 - 560 mm (-560)
 - 630 mm (-630)

- Length:
 - 1-part: 500 / 750 / 1000 (-0500/-0750/-1000).
 - 2-part: 1500 / 1750 / 2000 (-1500/-1750/-2000).

- Material and paint (round duct):
 - Galvanised sheet steel (-SV-0000).
 - Sheet steel painted to RAL 9010 (white) (standard, -SB-9010)
 - Sheet steel painted to a freely selectable RAL colour (-SB-xxxx) (colour always with 4 digits).

- Nozzle colour:
 - Plastic similar to RAL colour 9005 (black, standard) (-DS).
 - Plastic similar to RAL colour 9010 (white).

- Nozzle rows:
 - 1 (-1, standard).
 - 2 (-2).
 - 4 (-4) (from NW 400).

- Mounting position:
 - 3 o'clock (-3U).
 - 6 o'clock (-6U, standard).
 - 9 o'clock (-9U).
 - 12 o'clock (-0U).

- Fastening methods:
 - fastening hole
 - without fastening hole (-B0).
 - with fastening hole $\varnothing 11.5$ mm (-BB, standard). (Prepared for suspended installation by using an M8 threaded rod and an M8 nut to be provided on site).

Accessories (at an extra charge):

- Hit-and-miss damper:
 - without hit-and-miss damper (-SN) (standard).
 - With integrated hit-and-miss damper (-SS) for simple air volume and ductwork regulation, made of the same material as the round duct.

- Rubber lip seal
 - without rubber lip seal (-GD0) (standard).
 - with rubber lip seal (-GD1), on both sides, made of EPDM.

For more accessories, please refer to the separate documentation "Round duct system accessories".