**DBB**
Ceiling air diffuser**Contents**

Function and use	2
Models.....	2
Mounting	2
Processing.....	2
Accessories	3
Air throw.....	4
Dimensions	5
Dimensions of accessories.....	7
Mounting options	11
Technical data.....	13
Legend	24
Order code DBB	25
Order code AK	26
Specification text	27

FUNCTION AND USE

The characteristic feature of the ceiling air diffuser type DBB for supply and return air is its high flexibility. The integrated blades allow many air distribution patterns even later on. It is often the case that unforeseen installations of components into the ceiling make it necessary to change the air throw pattern on site. Some of the many available air throw options are shown below.

Attention:

As standard, the ceiling air diffuser type DBB-...-A-... in return air model is delivered with blades. Only for large air volumes will the DBB return air model be delivered without blades on request by the customer. Assembly parts such as plenum boxes or hit-and-miss dampers are painted black on the inside (RAL9005)

MODELS

DBB-A-...	longitudinal slots only.
DBB-B-...	longitudinal slots and transverse slots on one side. (available from length 425 mm / height 215 mm)
DBB-C-...	longitudinal slots and transverse slots on both sides. (available from length 425 mm / height 215 mm)
DBB-...-Z1-...	supply air 1-way (for DBB-A)
DBB-...-Z2-...	supply air 2-way (for DBB-A and DBB-B)
DBB-...-Z3-...	supply air 3-way (for DBB-B and DBB-C)
DBB-...-Z4-...	supply air 4-way (for DBB-C)
DBB-...-AA-...	return air without blades
DBB-...-AB-...	return air with blades
DBB-...-N-...	single design (standard)
DBB-...-B-...	band design (available lengths according to SCHAKO standard for band design) (for length BL > 1225 mm, module length max. 1225 mm, only possible for model DBB-A).

MOUNTING

- Screw mounting (-SM, standard)
 - screws must be provided on site
- Concealed mounting (-VM, standard for faceplate made of aluminium)
 - only possible with plenum box (plenum box can also be provided on site).
 - the counter pole brace to be provided by customer when delivered without plenum box.
 - In concealed mounting, the ceiling air diffuser is fixed to the plenum box with a pole brace and hexagonal socket head screws (DIN EN ISO 4762 M6).

PROCESSING

Faceplate

- Sheet steel (-SB-...):
 - painted to the RAL colour 9010 (white, standard) (-9010).
 - painted to another RAL colour, freely selectable (-xxxx).
- Galvanised sheet steel (-SV-0000) (only possible without paint).
- Natural colour anodised aluminium (E6/EV1, only possible with concealed mounting, only possible with ELOX paint) (-AL-ELOX).

Blade colour

- Without blades (-00000) (standard for return air).
- Plastic:
 - similar to RAL colour 9005 (black) (-L9005).
 - similar to RAL colour 9010 (white, standard) (-L9010).
- Aluminium:
 - painted to the RAL colour of the faceplate (at an extra charge). The painted blades cannot be adjusted subsequently (-Axxxx).
 - natural colour anodised (-AELOX).

ACCESSORIES

Plenum box (-AK-48/-AK-50)

Rectangular design, made of galvanised sheet steel (-SV, standard), housing with round connection spigot and mounting brackets.

- Air diffuser:
 - for ceiling air diffuser DBB-...-A... (return air) (-48) (inside painted to RAL colour 9005 [black]).
 - for ceiling air diffuser DBB-...-Z... (supply air) (-50) (with integrated perforated straightener).
- Length:
 - 325 mm (-00325)
 - 425 mm (-00425)
 - 525 mm (-00525)
 - 625 mm (-00625)
 - 825 mm (-00825)
 - 1025 mm (-01025)
 - 1225 mm (-01225)
 - length in mm, freely selectable, for band design (for length BL > 1225 mm: 2-part for a length of band BL ≤ 2437 mm, multi-part for a length of band > 2437 mm) (always with 5 digits).
- Height:
 - 115 mm (-115)
 - 215 mm (-215)
 - 315 mm (-315)
- Single / band design:
 - single design (-N) (standard).
 - band design (-B) (for length BL > 1225 mm, available lengths according to SCHAKO standard for band design).
- Mounting:
 - Screw mounting (-SM) (standard, screws must be provided on site).
 - concealed mounting (-VM).
- Damper:
 - without damper (-DK0) (standard).
 - with damper (-DK1), made of galvanised sheet steel, in the plenum box housing, adjustable, for simple air volume regulation. Standard with lateral spigot position (-S1).
 - with damper (-DK2), same as DK1, but with cable-operated adjustment, standard with spigot position from above (-S0) and front side spigot position (-S4).
- Rubber lip seal:
 - without rubber lip seal (-GD0) (standard).
 - with rubber lip seal (-GD1) made of special rubber, at the connection spigot.
- Insulation:
 - without insulation (-I0) (standard).
 - with internal insulation (-Ii), thermal insulation inside the plenum box.
 - with external insulation (-Ia), thermal insulation at the outside of the plenum box.
- Height of plenum box:
 - Standard height of plenum box (-KHS).
 - height of plenum box in mm, freely selectable (-xxx) (minimum height [KHS] with spigot positions -S1 and -S4 = spigot diameter + 87 mm, but at least 200 mm) (always with 3 digits).

- Spigot diameter:
 - Standard spigot diameter (-SDS).
 - spigot diameter in mm, freely selectable (-xxx, always with 3 digits) (with spigot positions -S0 and -S4, if the spigot diameter is increased, only the offset plenum box shape is available).
- Spigot position:
 - Spigot from above (-S0).
 - Lateral spigot on the plenum box (-S1) (standard).
 - Front side spigot (-S4, not possible for band design).

Hit-and-miss damper (-SN / -SS)

- without hit-and-miss damper (-SN) (standard).
- with hit-and-miss damper (-SS)
 - for air volume regulation, made of galvanised sheet steel.
 - VM model is only possible with plenum box or on-site counter pole.

Ball-impact guard (-B0 / -BS)

- without ball-impact guard (-B0) (standard).
- with ball-impact guard (-BS)
 - not possible for DBB-...-AL-ELOX.
 - steel painted to the RAL colour of the faceplate.

AIR THROW

Air throw	Model		
	DBB-A-...	DBB-B-...	DBB-C-...
...-Z1 (one-way throw)		--	--
...-Z2 (two-way throw)			--
...-Z3 (three-way throw)	--		
...-Z4 (four-way throw)	--	--	

BLADE POSITION

Longitudinal slots (LS):

DBB-A-Z1 DBB-A-Z2
 DBB-B-Z2 DBB-B-Z3
 DBB-C-Z3 DBB-C-Z4

Transverse slots (QS):

DBB-B-Z2 / DBB-B-Z3

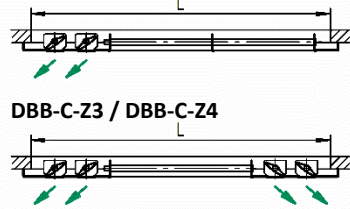
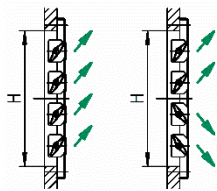

NUMBER OF BLADES

Longitudinal slots only:

DBB-A-...

		Longitudinal slots		
		2x	4x	6x
H	115	215	315	
		325		
L		425		
		525		
		625		
		825		
		1025		
		1225		

Longitudinal and transverse slots:

DBB-B-... / DBB-C-...

		Longitudinal slots		DBB-B	DBB-C	transverse slots
		4x	6x			
H	215	315				
		425		1x	2x	
L		525		2x	4x	
		625		2x	4x	
		825		3x	6x	
		1025		3x	6x	
		1225		4x	8x	

DIMENSIONS

SINGLE DESIGN (-N)

DBB-A-Z...-N...-SM... (supply air) /
 DBB-A-AB...-N...-SM... (return air, with blades)

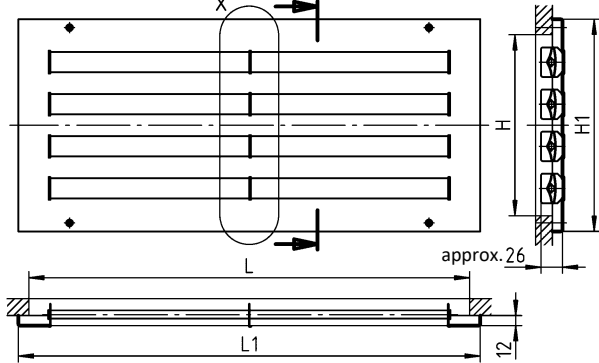

DBB-A-AA...-N...-SM... (return air, without blades)

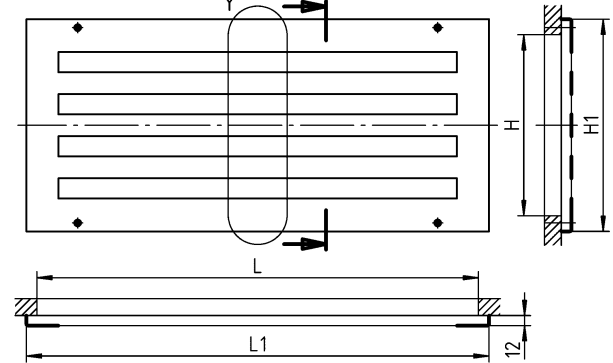

DBB-B-Z...-N...-SM... (supply air) /
 DBB-B-AB...-N...-SM... (return air, with blades)

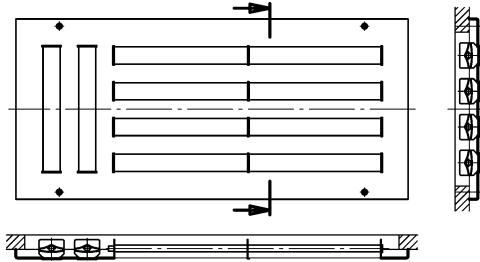

DBB-B-AA...-N...-SM... (return air, without blades)

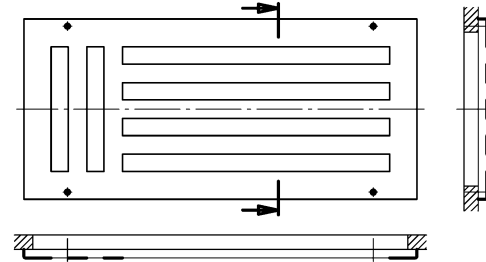

DBB-C-Z...-N...-SM... (supply air) /
 DBB-C-AB...-N...-SM... (return air, with blades)

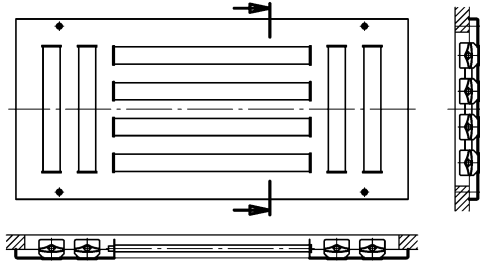

DBB-C-AA...-N...-SM... (return air, without blades)

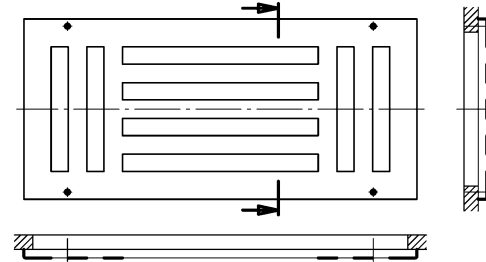

Available sizes DBB

L	L1	H	H1
325	350	115	152
425	450	215	252
525	550	315	352
625	650		
825*	850		
1025*	1050		
1225*	1250		

All combined lengths and heights available!

* Intermediate rail only with model DBB-A... (only longitudinal slots) from L ≥ 825.

Intermediate rail

detail X
 (with blades)

detail Y
 (without blades)

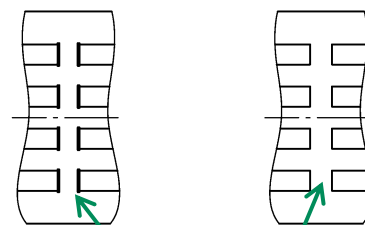

Intermediate rail
 Only for model DBB-A...
 (longitudinal slots only) from L ≥ 825

BAND DESIGN (-B)

Only possible for model DBB-A-... (longitudinal slots only).

Available lengths according to SCHAKO standard:

In the band design of the ceiling air diffuser DBB, the total length BL is assembled from two end pieces in the 2-part model and from sections (TS) of 1012 mm and end pieces (ES) in the multi-part model.

The end pieces can be manufactured with length from 506.5 to 1231 mm.

Without plenum box

2-part for a length of band BL > 1225 mm to ≤ 2437 mm

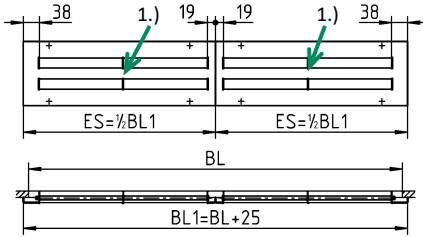

multi-part for a length of band BL > 2437 mm

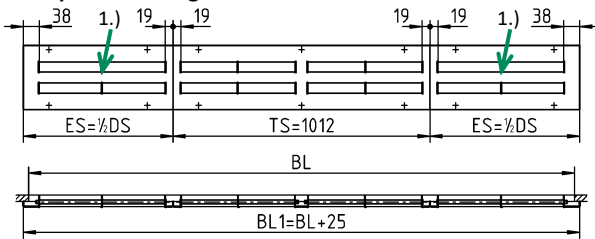

Max. length end piece (ES):

$ES_{max} = 1231 \text{ mm}$

1.) End piece $ES \geq 831$ with intermediate rail (for detail of intermediate rail, see page 5).

- ES = end piece
- KES = plenum box end piece (KES = ES-20)
- TS = section
- KTS = plenum box section
- DS = difference piece ($DS = BL1 - [n \times TS]$)
- N = number of sections
- BL = band length

For spigot position / plenum box shape, see pages 7+8
 For mounting options, see page 11

with plenum box

2-part for a length of band BL > 1225 mm to ≤ 2437 mm

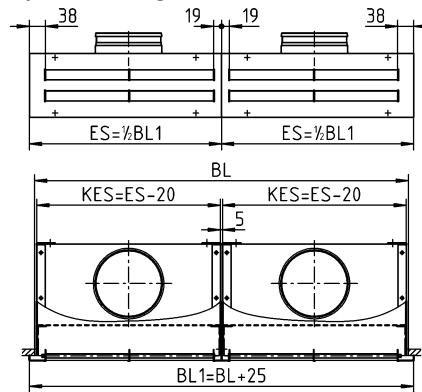

multi-part for a length of band BL > 2437 mm

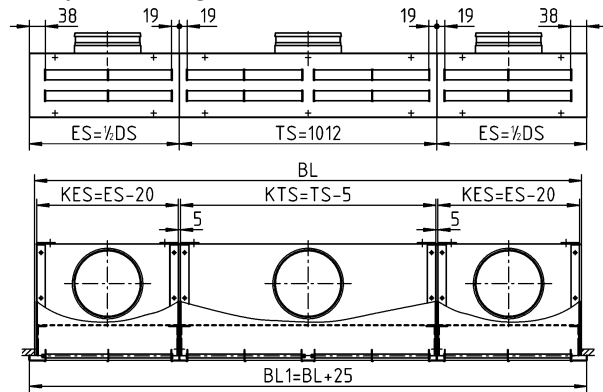

Max. length plenum box end piece (KES):

$KES_{max} = 1203.5 \text{ mm}$

Minimum distance spigot in the plenum box

with lateral spigot (-S1):

with spigot from above (-S0):

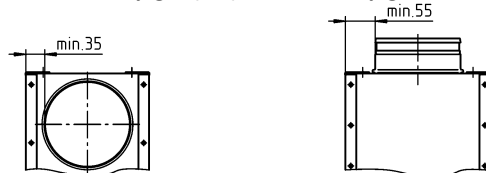

As standard, the plenum box end pieces (KES) have the same dimensions $KHS / KB2 / \varnothing D$ as the plenum box section (KTS) (for dimensions, see the table of available sizes, page 8, marking *).

DIMENSIONS OF ACCESSORIES

Plenum box (-AK-48 / -AK-50)

AK-48: for ceiling air diffuser DBB-...-A... (return air)
(inside painted to RAL colour 9005 [black]).

AK-50: for ceiling air diffuser DBB-...-Z... (supply air)
(with integrated perforated straightener).

SINGLE DESIGN (-N)

Spigot position

Straight plenum box:

Offset plenum box:

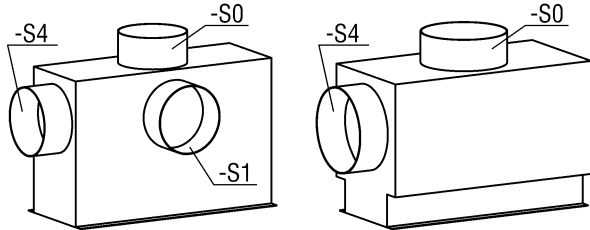

- Lateral spigot on the plenum box (-S1, standard)
- Spigot from above (-S0)
- Front side spigot (-S4, not possible for band design)

Spigot diameter for spigot position "Spigot front side (-S4)" is **identical** with "Lateral spigot on the box (-S1)".

Spigot diameter for spigot position "Spigot from above (-S0)" is **in part not identical** with "Lateral spigot on the box (-S1)".

For the table of available sizes and ceiling opening, see page 8.

Straight plenum box:

(models DBB-...-SM-...-SM are shown)

with spigot from above (-S0)

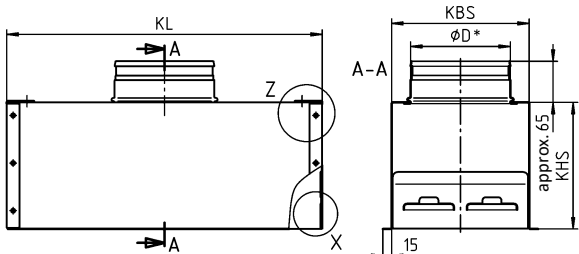

with lateral spigot on the plenum box (-S1, standard)

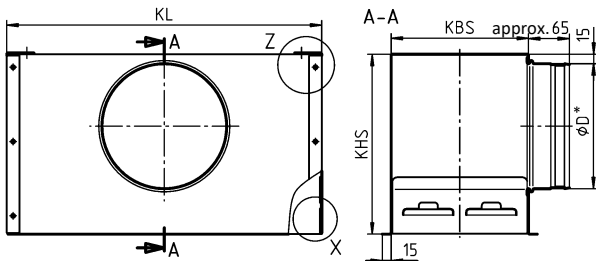

with spigot front side (-S4)

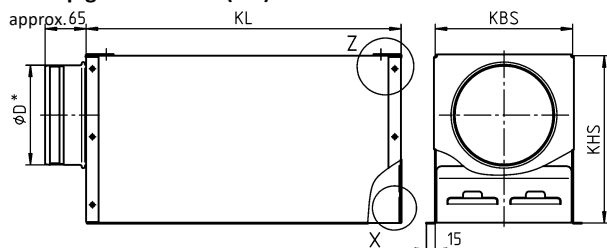

* external

Construction subject to change
No return possible

Offset plenum box:

If $KBS < (\phi D + 30)$, an offset plenum box will be manufactured.

For model -S0: $KB2 = \phi D + 30$

Minimum difference between KBS and KB2 = 40 mm.

with spigot from above (-S0)

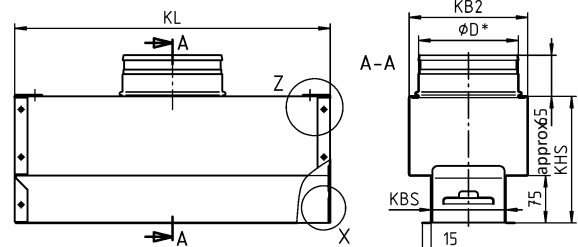

with lateral spigot on the plenum box (-S4)

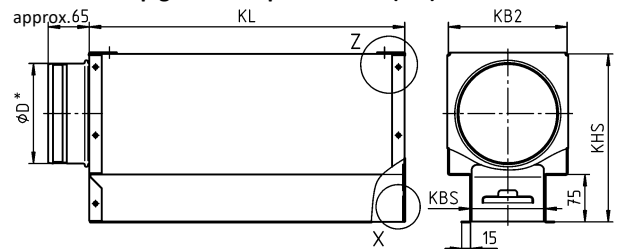

* external

Plenum box mounting:

Detail Z

As-delivered condition with fitted mounting bracket

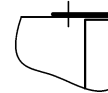

Detail Z

with bent fixing lug

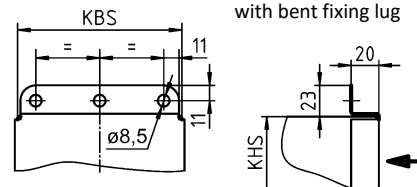

Detail X

Return air model (-48)

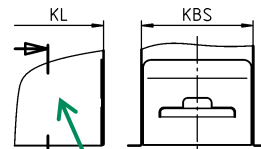

inside painted to RAL colour 9005 (black)

Supply air model (-50)

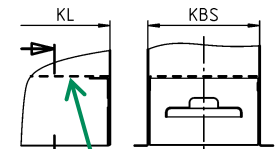

Perforated straightener

Minimum height KHS with spigot position -S1 / -S4:

$KHS_{min.} = \phi D + 87 \text{ mm}$, but at least 200 mm

Minimum width KB2 with spigot position -S0 / -S4:

$KB2_{min.} = \phi D + 30 \text{ mm}$

Minimum difference between KBS and KB2 = 40 mm.

The dimension KBS cannot be changed.

With spigot positions -S0 and -S4, if the spigot diameter is increased, only the offset plenum box shape is available.

For plenum box in band design, see page 6.

Available sizes AK-48 / AK-50

H	KBS	L	KL	Spigot position -S1 (standard)				Spigot position -S0				Spigot position -S4			
				KHS	KB2	n x øD	Plenum box shape	KHS	KB2	n x øD	Plenum box shape	KHS	KB2	n x øD	Plenum box shape
115	118	325	320	265	--	1x ø158		200*	158*		265	188	1x ø158		
		425	420												
		525	520												
		625	620	285*	--	1x ø198*		200*	158*		285	228	1x ø198		
		825	820												
		1025	1020												
1225	1220														
215	218	325	320	285	--	1x ø198		200*	258	1x ø198		285	258	1x ø198	
		425	420												
		525	520												
		625	620	335*	--	1x ø248*		200*	--	2x ø178*		335	278	1x ø248	
		825	820												
		1025	1020												
1225	1220														
315	318	325	320	335	--	1x ø248		200*	--	1x ø248		335	--	1x ø248	
		425	420												
		525	520												
		625	620	400*	--	1x ø313*		200*	--	2x ø222*		400	358	1x ø313	
		825	820												
		1025	1020												
1225	1220														

* dimensions for band design / n = number of spigots

Plenum box shape

Straight:

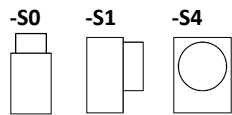

Offset:

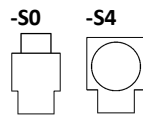

Minimum height KHS with spigot position -S1 / -S4:

$KHS_{min.} = \varnothing D + 87 \text{ mm, but at least } 200 \text{ mm}$

Minimum width KB2 with spigot position -S0 / -S4:

$KB2_{min.} = \varnothing D + 30 \text{ mm}$

Minimum difference between KBS and KB2 = 40 mm.

The dimension KBS cannot be changed.

With spigot positions -S0 and -S4, if the spigot diameter is increased, only the offset plenum box shape is available.

Ceiling opening in the height with AK-...-N-... :

$D\ddot{O}H = H + 10$

DÖH = ceiling opening in the height

Number of spigots:
 Spigot from above (-S0)

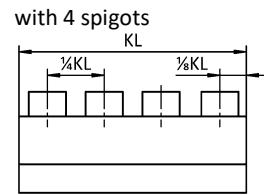
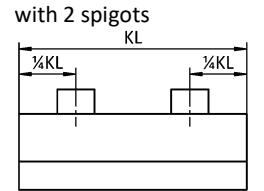
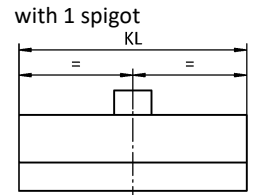

Lateral spigot (-S1)
 (standard)

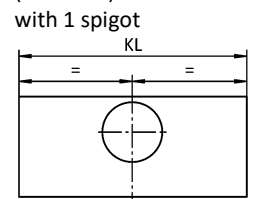

Spigot front side (-S4)

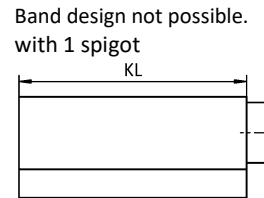

Damper (-DK0 / -DK1 / -DK2), for AK-...

- without damper (-DK0) (standard).
- with damper (-DK1) (standard for spigot position -S1).
- with damper and cable-operated adjustment (-DK2) (standard for spigot position -S0/-S4).

-DK1:

Lateral spigot -S1

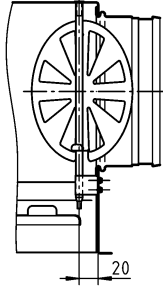

-DK2 (with cable-operated adjustment):
spigot from above -S0 spigot front side -S4

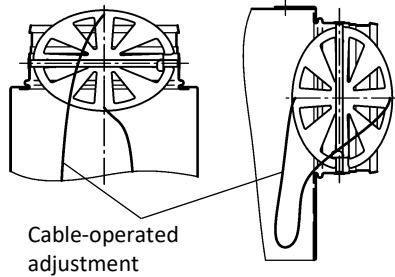

Rubber lip seal (-GD0 / -GD1), for AK-...

- without rubber lip seal (-GD0) (standard).
- with rubber lip seal (-GD1), made of special rubber.

Detail Y

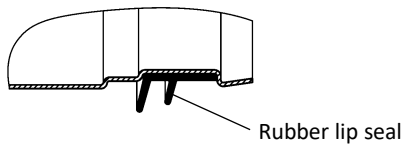

Insulation (-I0 / -Ii / -Ia), for AK-...

- without insulation (-I0) (standard).
- with internal insulation (-Ii).
- with external insulation (-Ia).

Internal insulation (-Ii)

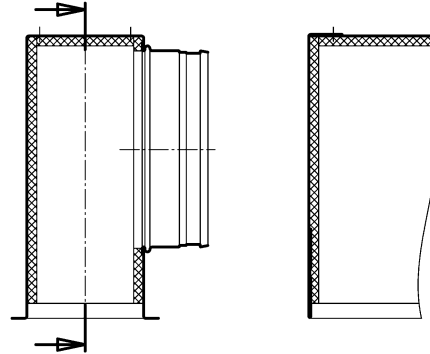

External insulation (-Ia)

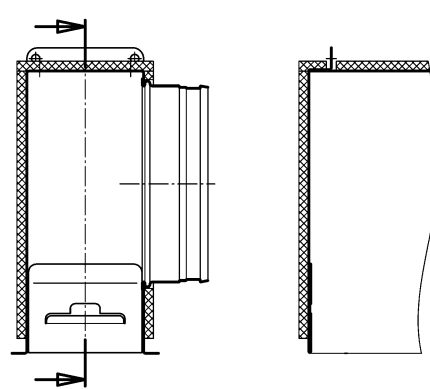

Hit-and-miss damper (-SN / -SS)

- without hit-and-miss damper (-SN) (standard).
- with hit-and-miss damper (-SS).

Installation is possible for SM and VM.

VM model is only possible with plenum box or on-site counter pole.

DBB-...-Z-...-SM-... (supply air, with screw mounting)

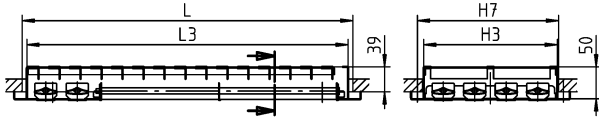

DBB-...-A-...-SM-... (return air, with screw mounting)

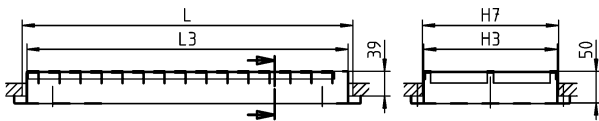

DBB-...-Z-...-VM-... (supply air, with concealed mounting)

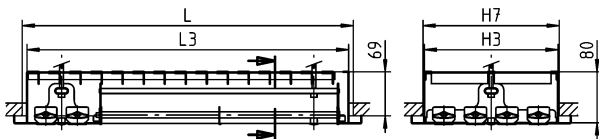

DBB-...-A-...-VM-... (return air, with concealed mounting)

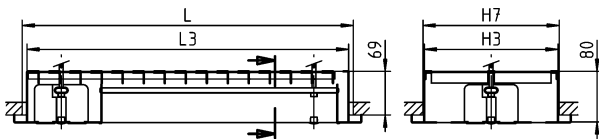

Ceiling opening AK-...-SS-... (with hit-and-miss damper):

DÖH = H7 (H + 1)
DÖL = L

DÖH = ceiling opening in the height
DÖL = ceiling opening in the length

Available sizes SS

L	L3	H	H3	H7
325	310	115	112	116
425	410	215	212	216
525	510	315	312	316
625	610			
825	810			
1025	1010			
1225	1210			

Ball-impact guard (-B0 / -BS)

- without ball-impact guard (-B0) (standard).
- with ball-impact guard (-BS).

Not possible for DBB-...-AL-ELOX.

Installation is possible for SM and VM.

Ball-impact guard is installed on site after mounting of the ceiling air diffuser DBB.

DBB-...-BS

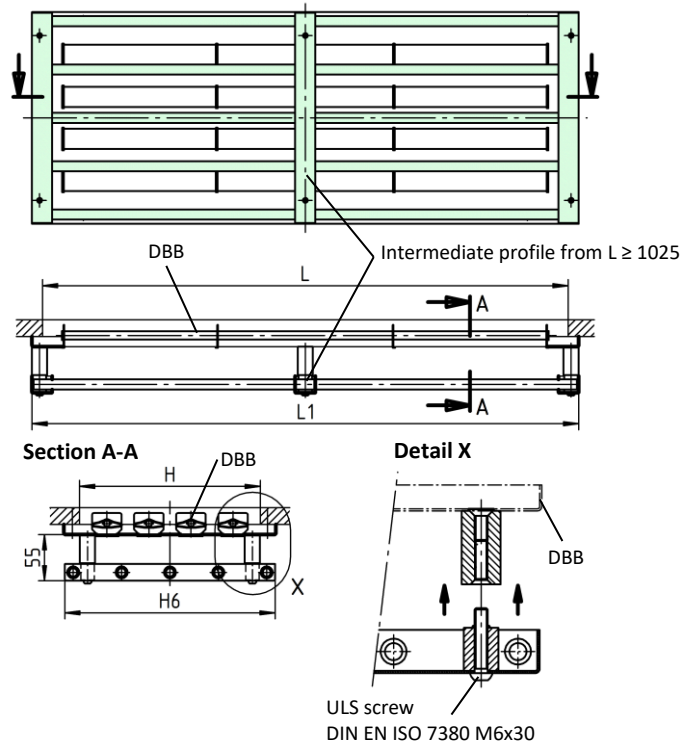

Available sizes BS

L	L1	H	H6
325	350	115	150
425	450	215	250
525	550	315	350
625	650		
825	850		
1025	1050		
1225	1250		

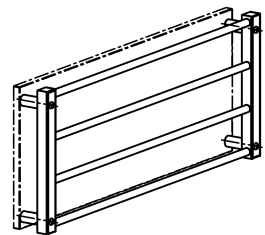

MOUNTING OPTIONS

Screw mounting (-SM, standard)

(model "DBB-A-..." is shown)

SINGLE DESIGN (-N)

With 4 indentations (L= 325-525)

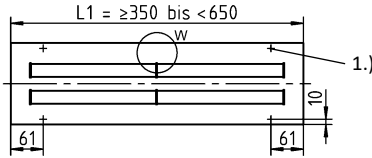

With 6 indentations (L= ≥625 to ≤1225)

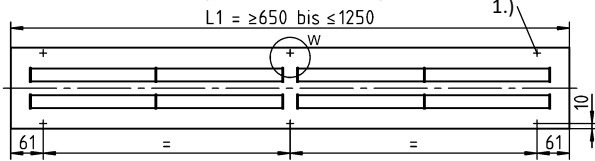

BAND DESIGN (-B)

Section - with 6 indentations (L1=1012)

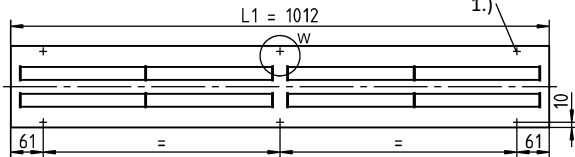

End piece - with 4 indentations (L1= ≥531 to <631)

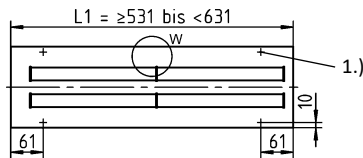

End piece - with 6 indentations (L= ≥631 to ≤1231)

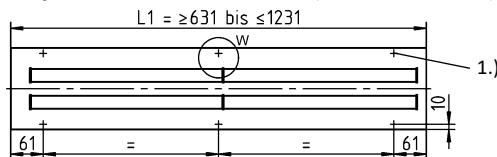

- 1.) With 4 or 6 indentations for slotted shallow-raised countersunk-head tapping screw DIN ISO 7051 pitch 3.9 (on site).

Detail of screw mounting

Without plenum box

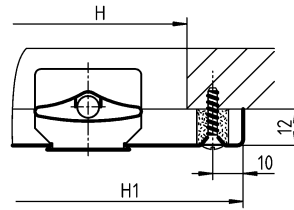

with plenum box

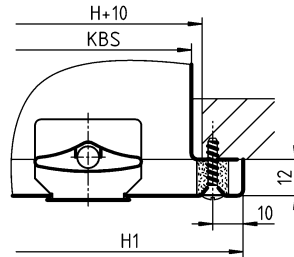

Available sizes

H	H1	KBS
115	152	118
215	252	218
315	352	318

Hole for the damper adjustment

(only available for the version with damper)

Detail W

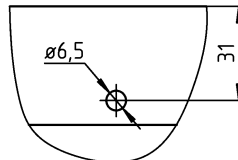

Concealed mounting (-VM)

- standard for faceplate made of aluminium.
- only possible with plenum box (plenum box can also be provided on site).
- the counter pole brace to be provided by customer when delivered without plenum box.
- In concealed mounting, the ceiling air diffuser is fixed to the plenum box with a pole brace and hexagonal socket head screws (DIN EN ISO 4762 M6).

DBB-A-Z-...-VM-... (supply air)

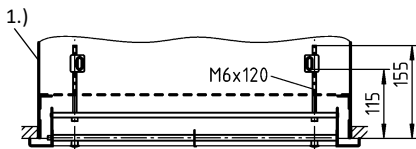
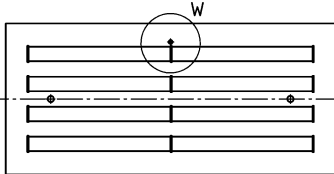

DBB-A-A-...-VM-... (return air)

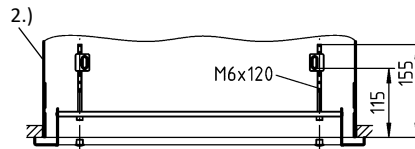
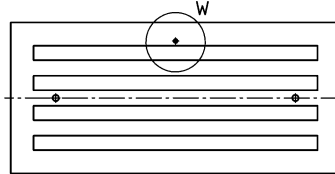

DBB-B-Z-...-VM-... (supply air)

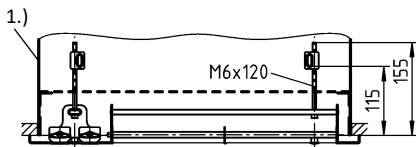
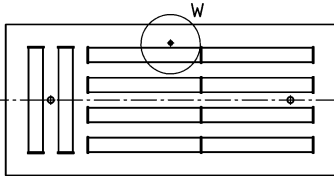

DBB-B-A-...-VM-... (return air)

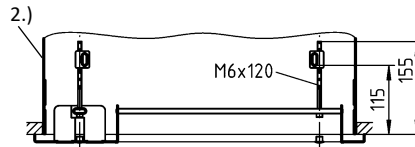
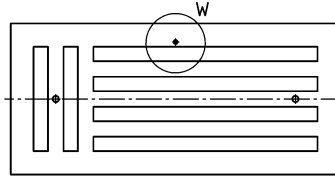

DBB-C-Z-...-VM-... (supply air)

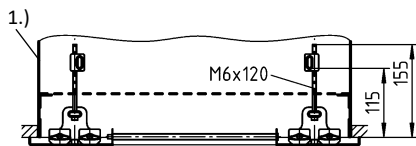
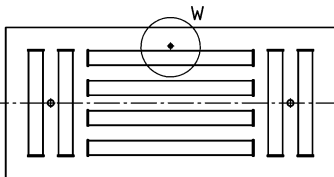

DBB-C-A-...-VM-... (return air)

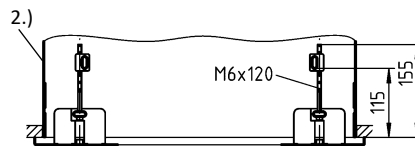
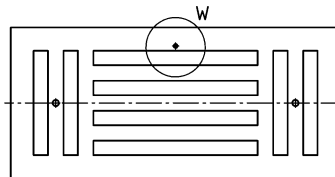

Attention: The max. torque of the fastening screw is 0.4 Nm!

- 1.) Plenum box AK-50 (supply air)
- 2.) Plenum box AK-48 (return air)

Hole for the damper adjustment
 (only available for the version with damper)

Detail W

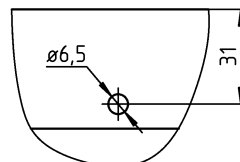

TECHNICAL DATA

Pressure loss and noise level

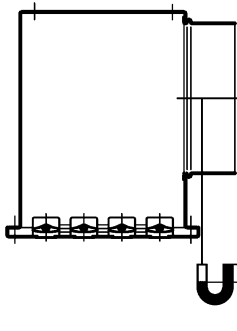

the following applies to damper
 "CLOSED":

$\Delta p_t = \text{diagram value} \times 2$
 $L_{WA} = \text{diagram value} + 5 \text{ dB(A)}$

DBB-A-..., H = 115 mm (damper OPEN)

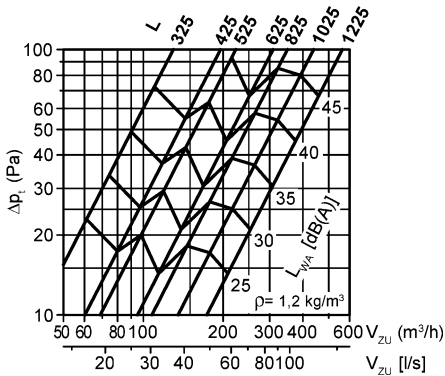

DBB-A-..., H = 215 mm (damper OPEN)

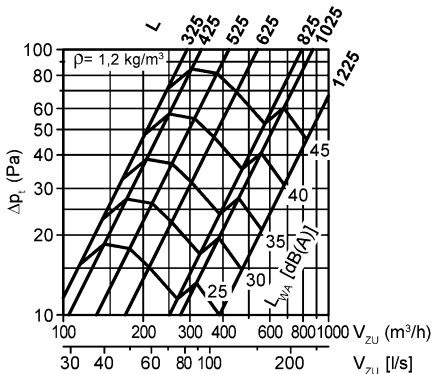

DBB-A-..., H = 315 mm (damper OPEN)

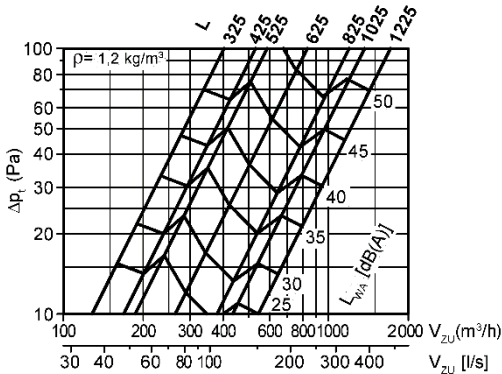

DBB-B-..., H = 215 mm (damper OPEN)

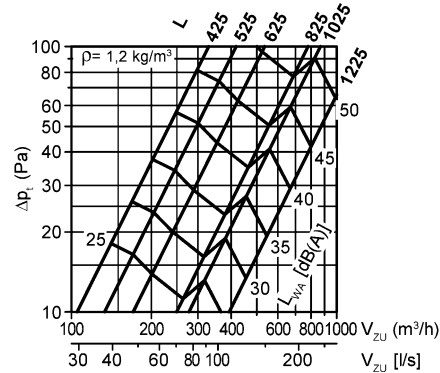

DBB-B-..., H = 315 mm (damper OPEN)

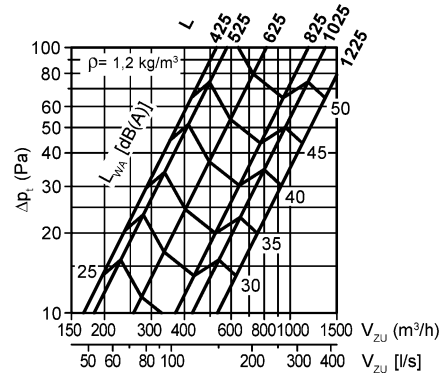

DBB-C-..., H = 215 mm (damper OPEN)

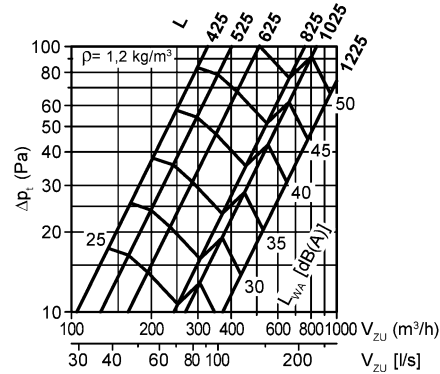

DBB-C-..., H = 315 mm (damper OPEN)

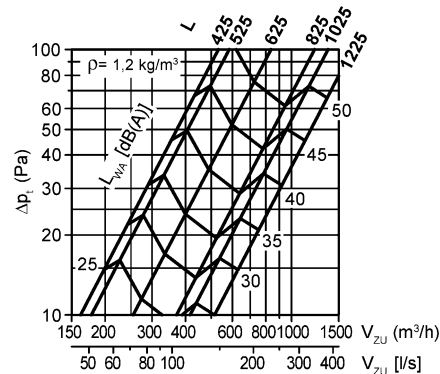

Maximum end velocity of jet

DBB-A-..., with coanda effect
 one- or two-way throw

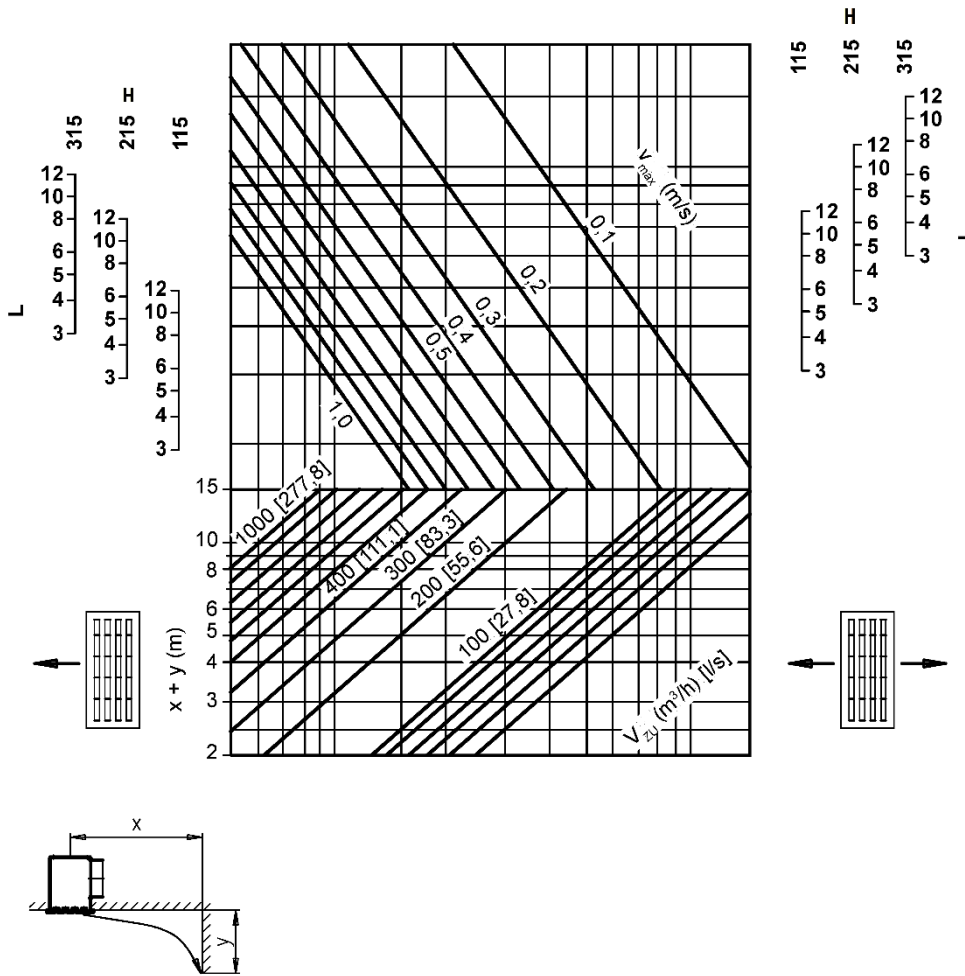

without coanda effect: diagram value x 0.7

- L 3 = length 325 mm
- L 4 = length 425 mm
- L 5 = length 525 mm
- L 6 = length 625 mm
- L 8 = length 825 mm
- L 10 = length 1025 mm
- L 12 = length 1225 mm

DBB-B-..., with coanda effect
 two- or three-way throw

Air flow direction sideways

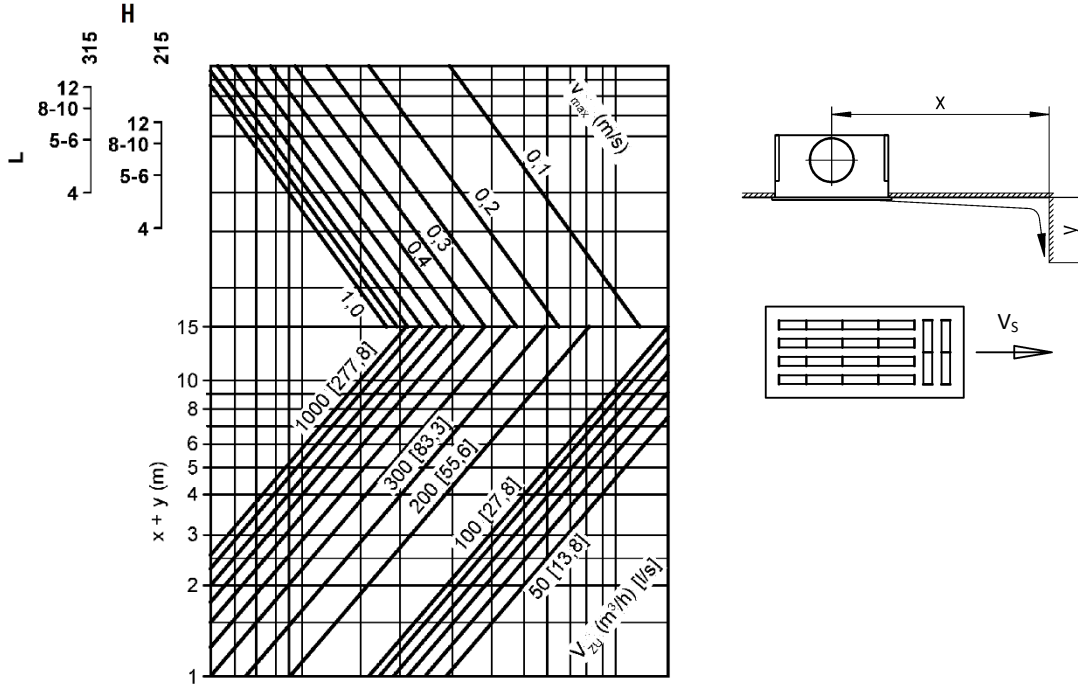

Main air flow direction

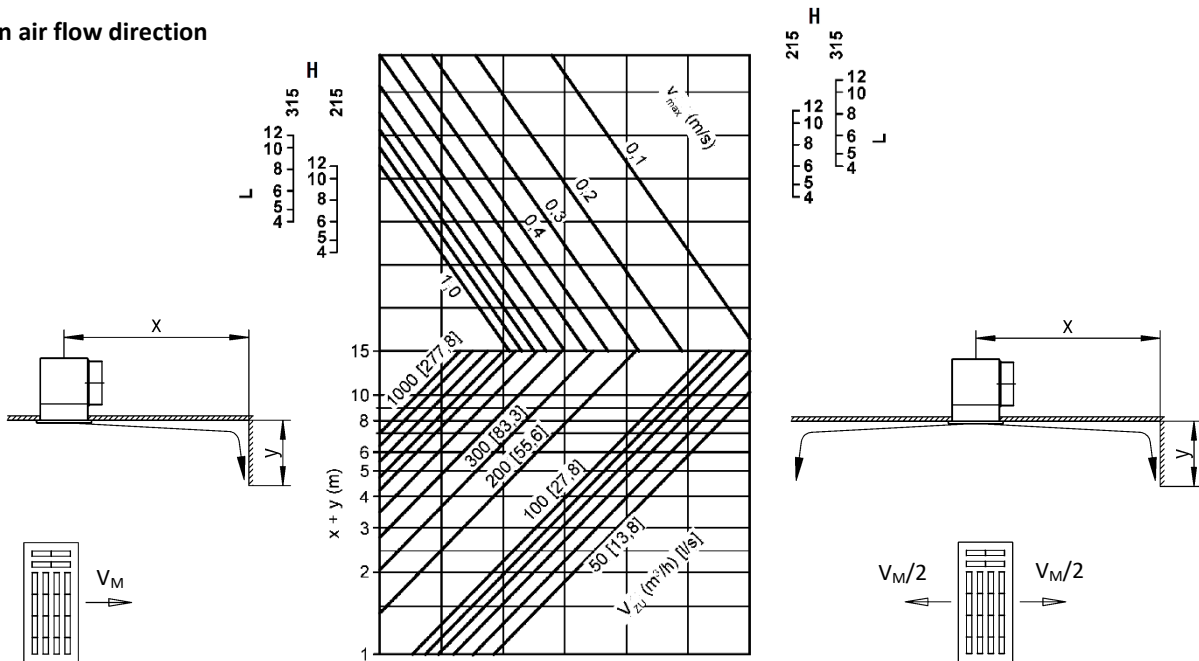

without coanda effect: diagram x 0.7

$$V_s = V_{Seite} = V_{Zu} \times 0.16$$

$$V_M = V_{Mitte} = V_{Zu} \times 0.84$$

- L3 = length 325 mm
- L4 = length 425 mm
- L5 = length 525 mm
- L6 = length 625 mm
- L8 = length 825 mm
- L10 = length 1025 mm
- L12 = length 1225 mm

DBB-C-..., with coanda effect
three- or four way throw

Air flow direction sideways

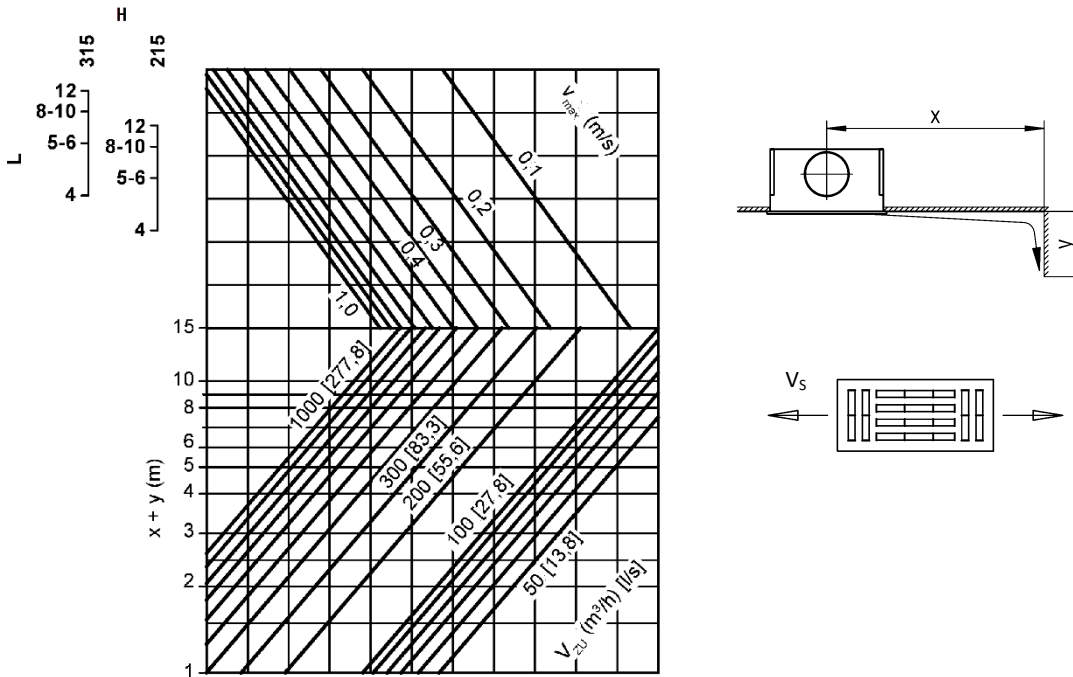

Main air flow direction

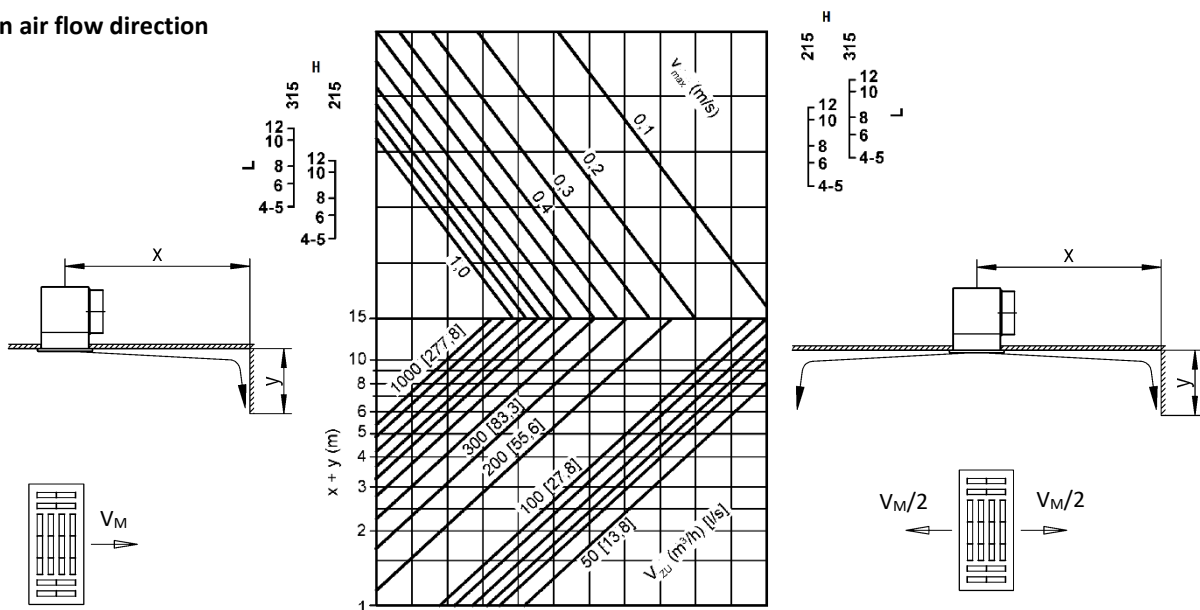

without coanda effect: diagram x 0.7

$$V_s = V_{Seite} = V_{ZU} \times 0.15$$

$$V_M = V_{Mitte} = V_{ZU} \times 0.7$$

- L 3 = length 325 mm
- L 4 = length 425 mm
- L 5 = length 525 mm
- L 6 = length 625 mm
- L 8 = length 825 mm
- L 10 = length 1025 mm
- L 12 = length 1225 mm

Jet path

DBB-A-..., without coanda effect
 one- or two-way throw

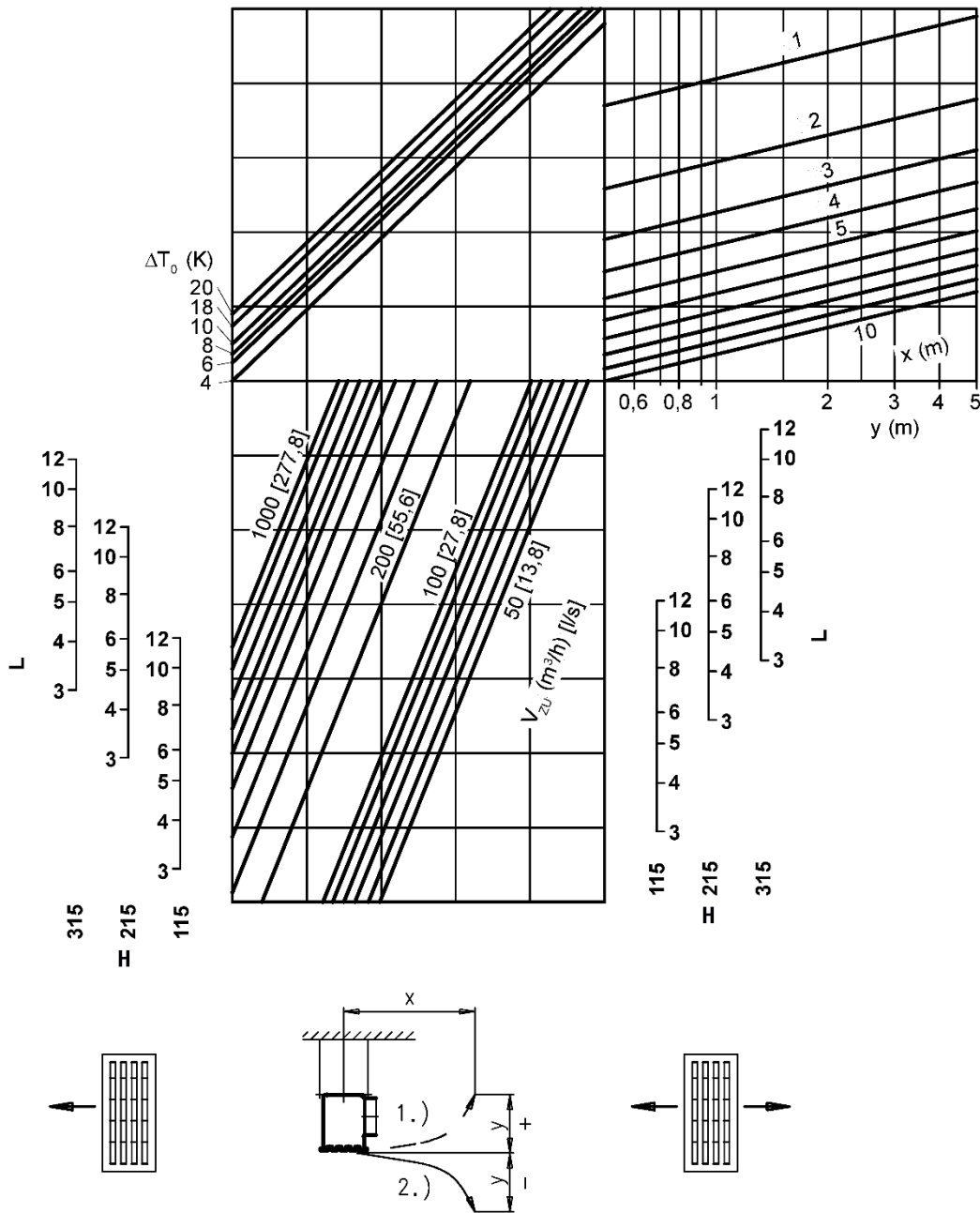

- 1.) Heating mode
- 2.) Cooling mode

- L 3 = length 325 mm
- L 4 = length 425 mm
- L 5 = length 525 mm
- L 6 = length 625 mm
- L 8 = length 825 mm
- L 10 = length 1025 mm
- L 12 = length 1225 mm

DBB-B-..., without coanda effect
 two- or three-way throw

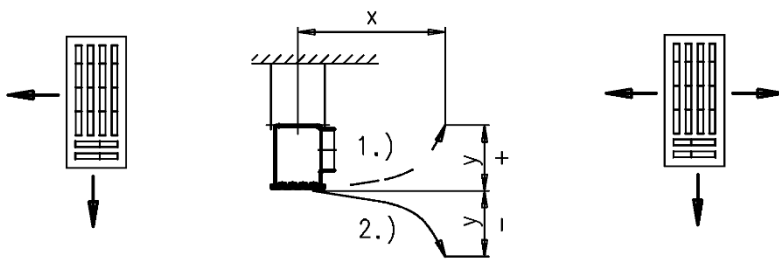
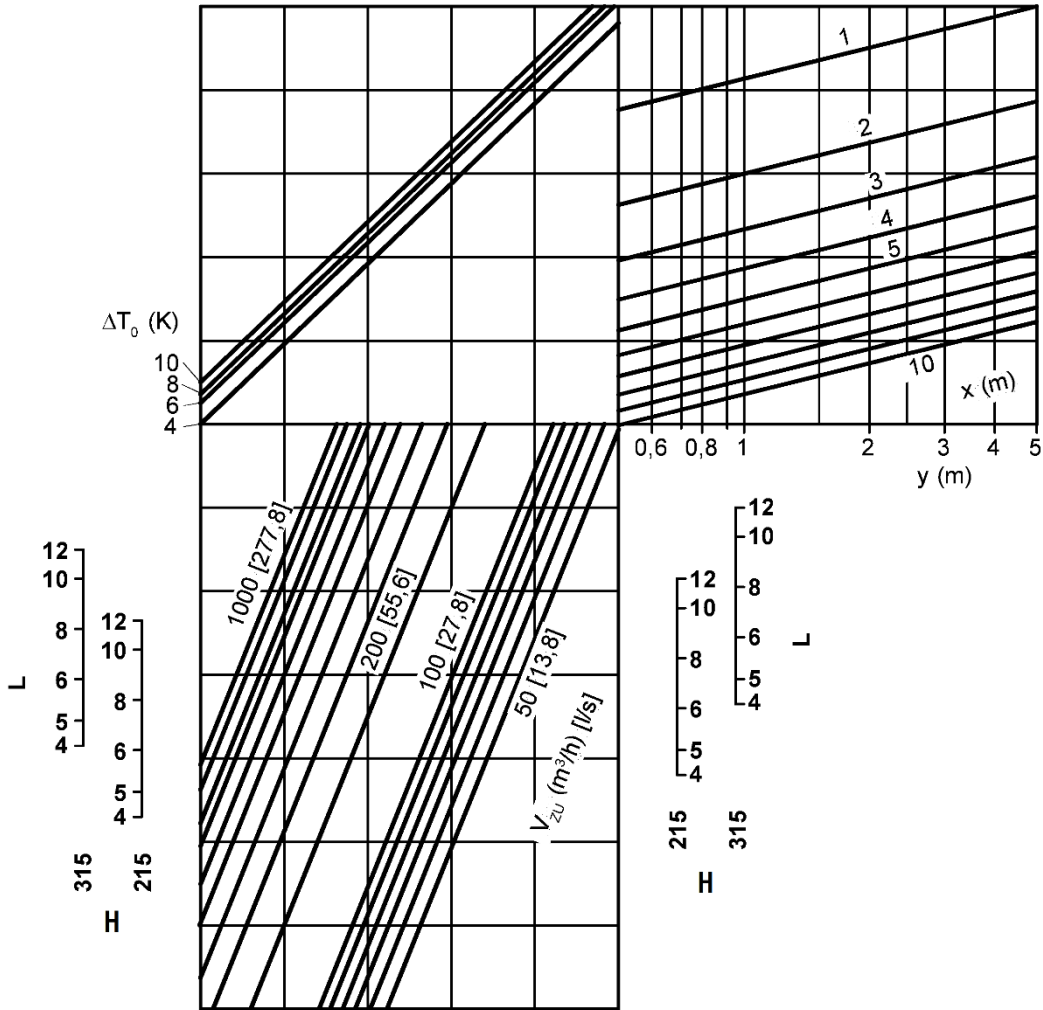

- 1.) Heating mode
- 2.) Cooling mode

- L3 = length 325 mm
- L4 = length 425 mm
- L5 = length 525 mm
- L6 = length 625 mm
- L8 = length 825 mm
- L10 = length 1025 mm
- L12 = length 1225 mm

DBB-C-..., without coanda effect
 three- or four way throw

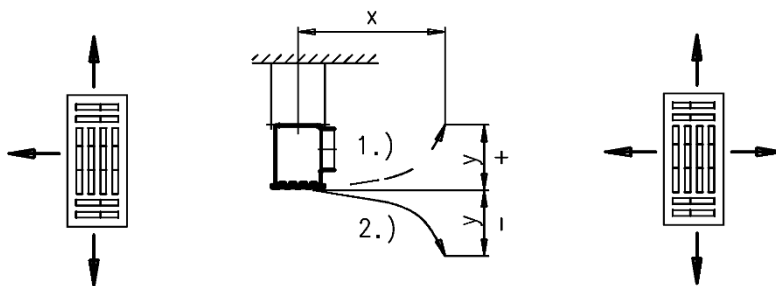
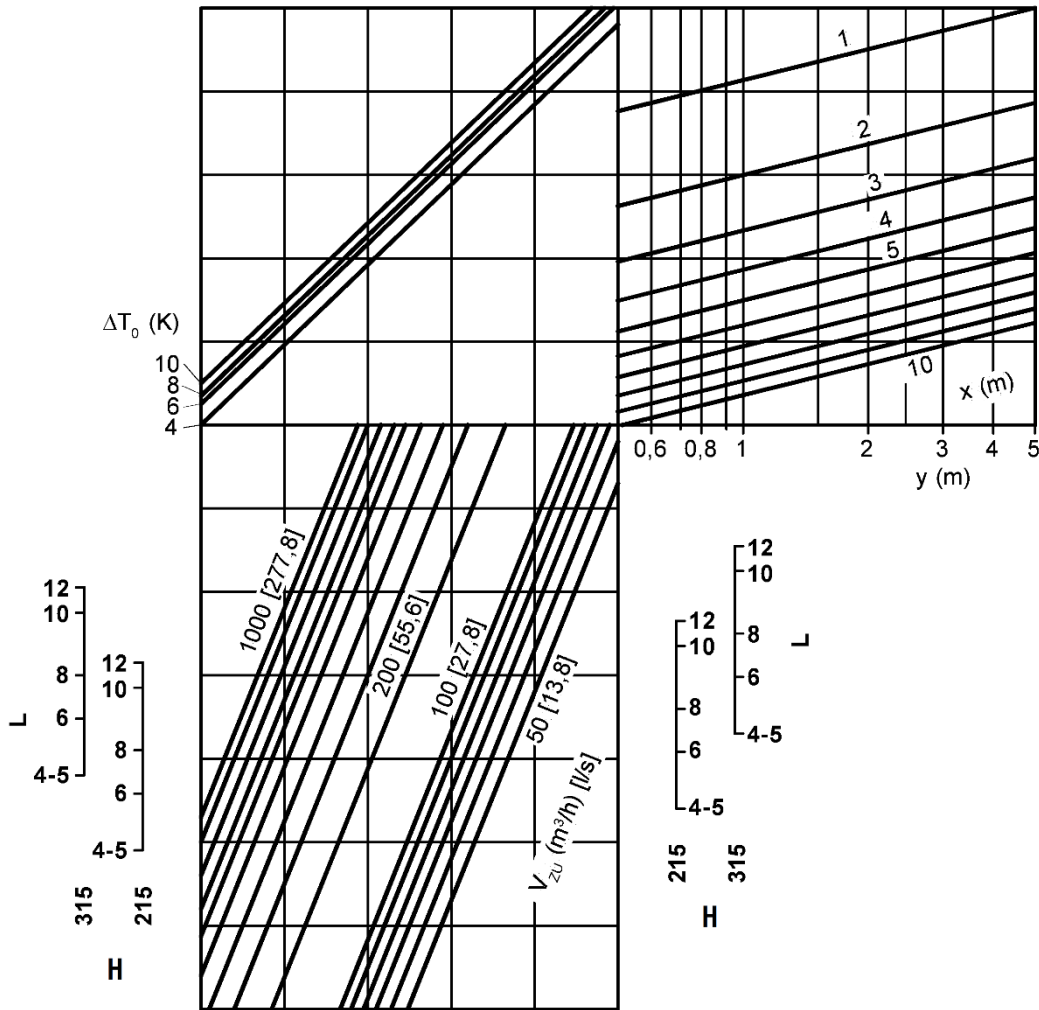

- 1.) Heating mode
- 2.) Cooling mode

- L 3 = length 325 mm
- L 4 = length 425 mm
- L 5 = length 525 mm
- L 6 = length 625 mm
- L 8 = length 825 mm
- L 10 = length 1025 mm
- L 12 = length 1225 mm

Critical throw

DBB-A-..., with coanda effect
 one- or two-way throw

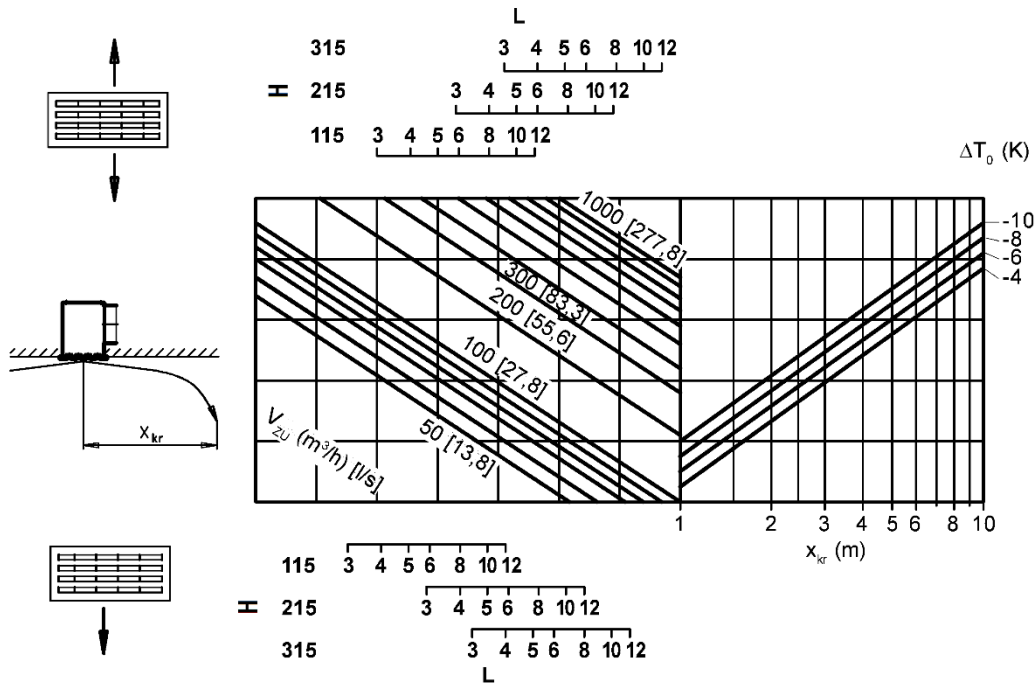

DBB-B-..., with coanda effect
 two- or three-way throw

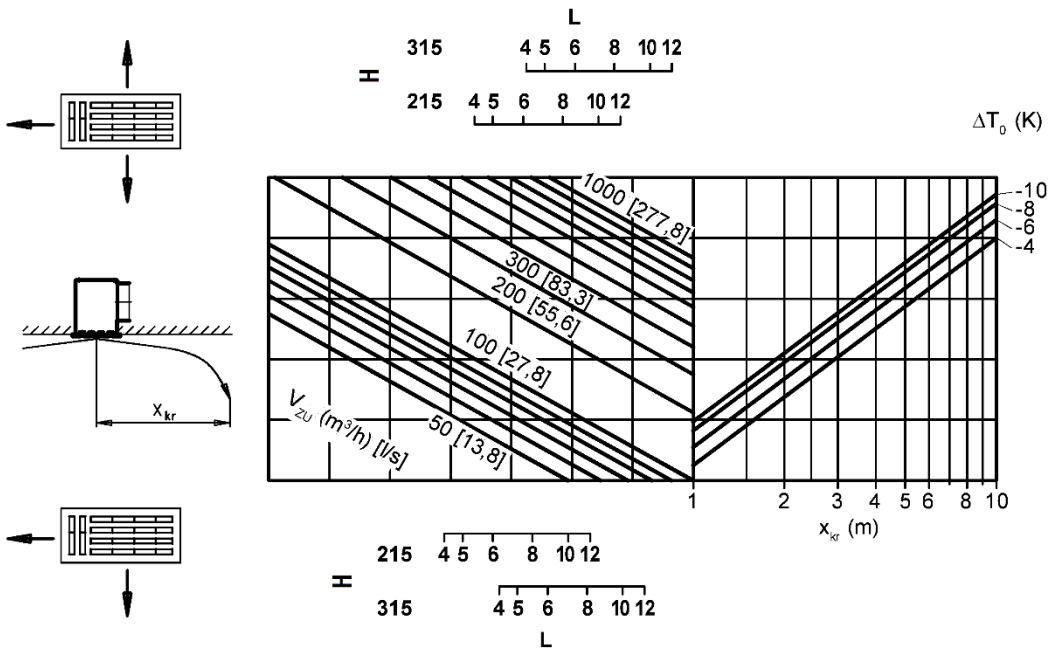

- L 3 = length 325 mm
- L 4 = length 425 mm
- L 5 = length 525 mm
- L 6 = length 625 mm
- L 8 = length 825 mm
- L 10 = length 1025 mm
- L 12 = length 1225 mm

DBB-C-..., with coanda effect
 three- or four way throw

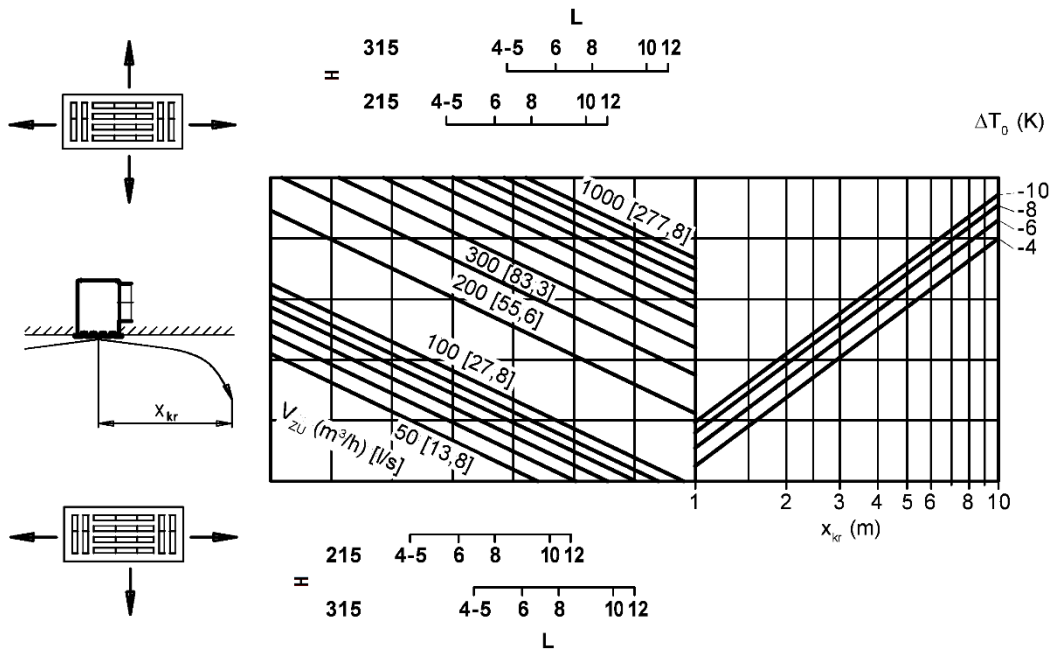

- L 3 = length 325 mm
- L 4 = length 425 mm
- L 5 = length 525 mm
- L 6 = length 625 mm
- L 8 = length 825 mm
- L 10 = length 1025 mm
- L 12 = length 1225 mm

Induction ratio

DBB-A-..., with coanda effect
one- or two-way throw

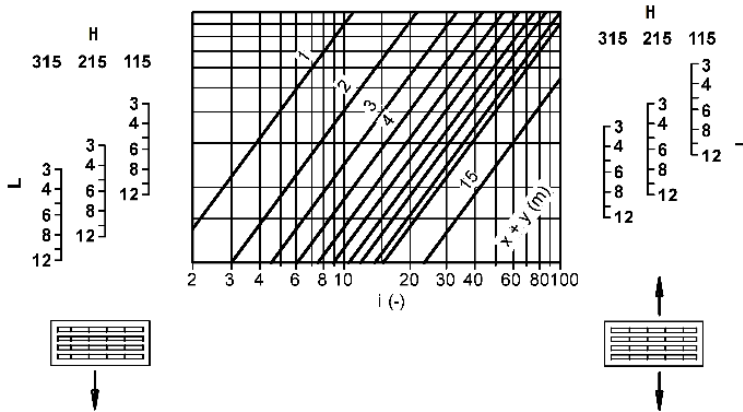

without coanda effect: diagram value x 1.4

DBB-B-..., with coanda effect
two- or three-way throw

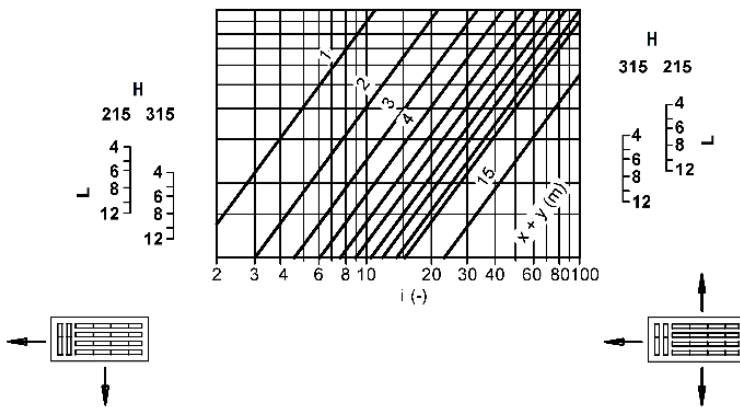

without coanda effect: diagram value x 1.4

DBB-C-..., with coanda effect
three- or four way throw

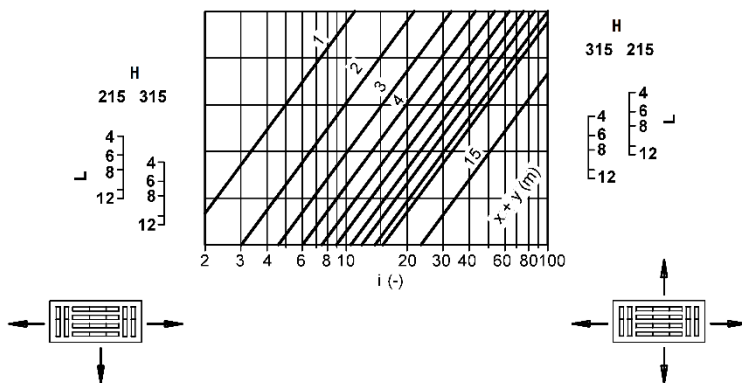

without coanda effect: diagram value x 1.4

- L 3 = length 325 mm
- L 4 = length 425 mm
- L 5 = length 525 mm
- L 6 = length 625 mm
- L 8 = length 825 mm
- L 10 = length 1025 mm
- L 12 = length 1225 mm

Temperature ratio

**DBB-A-..., with coanda effect
 one- or two-way throw**

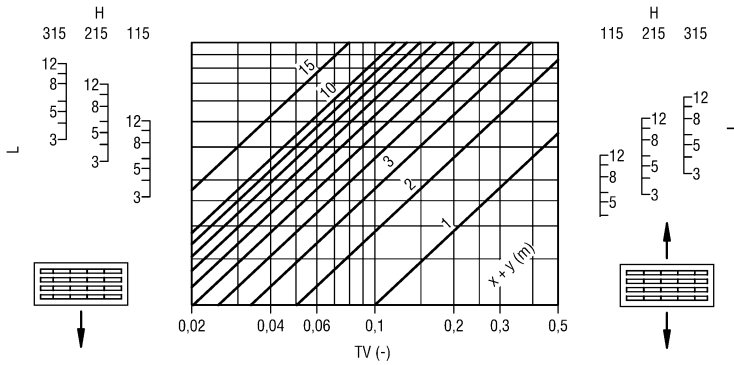

without coanda effect: diagram value x 0.7

**DBB-B-..., with coanda effect
 two- or three-way throw**

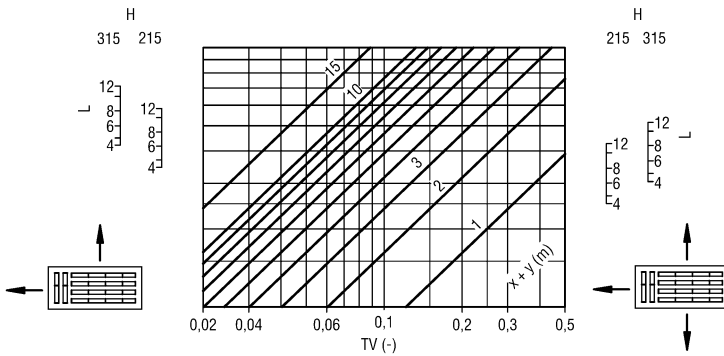

without coanda effect: diagram value x 0.7

**DBB-C-..., with coanda effect
 three- or four way throw**

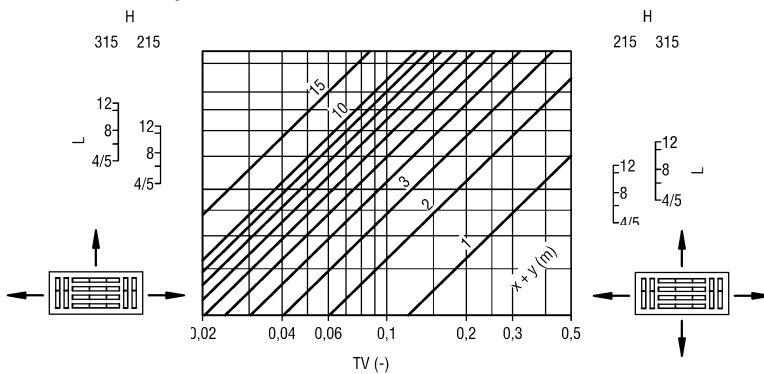

without coanda effect: diagram value x 0.7

- L 3 = length 325 mm
- L 4 = length 425 mm
- L 5 = length 525 mm
- L 6 = length 625 mm
- L 8 = length 825 mm
- L 10 = length 1025 mm
- L 12 = length 1225 mm

LEGEND

V_{ZU}	(m ³ /h) [l/s]	= supply air volume
V_x	(m ³ /h) [l/s]	= total air jet volume at point x
v_{max}	(m/s)	= max. End velocity of jet
x	(m)	= horizontal throw
y	(m)	= vertical throw
x+y	(m)	= horizontal + vertical throw
x_{kr}	(m)	= critical throw
ρ	(kg/m ³)	= density
Δp_t	(PA)	= pressure loss
L_{WA}	[dB(A)]	= A-weighted sound power level ($L_{WA} = L_{WA1} + KF$)
KF	(-)	= Correction factor
ΔT_0	(K)	= temperature difference between supply air temperature and room temperature ($\Delta T_0 = t_{ZU} - t_R$)
ΔT_x	(K)	= temperature difference at point x
i	(-)	= induction ratio ($i = V_x / V_{ZU}$)
TV	(-)	= temperature ratio ($TV = \Delta T_x / \Delta T_0$)
H	(mm)	= Height
L	(mm)	= length
t_{ZU}	(°C)	= supply air temperature
t_R	(°C)	= room temperature

ORDER CODE DBB

01	02	03	04	05	06
Type	Model	Air throw	Length	Height	Single / band design
Example					
DBB	-A	-Z1	-00625	-115	-N

07	08	09	10	11	12
Material	Paint	Blade colour	Mounting	Hit-and-miss	Ball-impact guard
-SB	-9010	-L9010	-SM	-SN	-B0

All fields must be filled when ordering.

Sample

DBB-A-Z1-00625-115-N-SB-9010-L9010-SM-SN-B0

+Ceiling air diffuser DBB | longitudinal slots only | supply air 1-way | length 625 mm | height 115 mm | single design | sheet steel | painted to RAL colour 9010 | plastic, painted to a colour similar to RAL 9010 (white) | screw mounting | without hit-and-miss damper | without ball-impact guard

ORDER DETAILS

01 - Type

DBB = ceiling air diffuser DBB

02 - Model

A = longitudinal slots only.
 B = longitudinal slots and transverse slots on one side (available from length 425 mm / height 215 mm).
 C = longitudinal slots and transverse slots on both sides (available from length 425 mm / height 215 mm).

03 - Air throw

Z1 = supply air 1-way (for DBB-A)
 Z2 = supply air 2-way (for DBB-A and DBB-B)
 Z3 = supply air 3-way (for DBB-B and DBB-C)
 Z4 = supply air 4-way (for DBB-C)
 AA = return air without blades
 AB = return air, with blades

04 - Length

00325 = length 325 mm
 00425 = length 425 mm
 00525 = length 525 mm
 00625 = length 625 mm
 00825 = length 825 mm
 01025 = length 1025 mm
 01225 = length 1225 mm
 xxxxx = length in mm, for band design (for length BL > 1225 mm: 2-part for a length of band BL ≤ 2437 mm, multi-part for a length of band > 2437 mm) (always with 5 digits).

05 - Height

115 = height 115 mm
 215 = height 215 mm
 315 = height 315 mm

06 - Single / band design

N = single design (standard)
 B = band design (available lengths according to SCHAKO standard for band design) (for length BL > 1225 mm, module length max. 1225 mm, only possible for model DBB-A).

07 - Material

SB = sheet steel (standard)
 SV = galvanised sheet steel (only possible without paint).
 AL = aluminium (only possible with concealed mounting, only possible with ELOX paint).

08 - Paint

0000 = without paint (only -SV possible).
 9010 = painted to the RAL colour 9010 (white, standard) (only possible for -SB).
 xxxx = painted to a different RAL colour, freely selectable (only possible for -SB) (always with 4 digits).
 ELOX = natural colour anodised (E6/EV1) (only -AL possible).

09 - Blade colour

00000 = without blades (standard for return air)
 L9005 = plastic, similar to RAL colour 9005 (black) (standard).
 L9010 = plastic, similar to RAL colour 9010 (white).
 Axxxx = aluminium painted to the RAL colour of the faceplate (subsequent adjustment not possible) (always with 5 digits).
 AELOX = natural colour anodised aluminium (E6/EV1).

10 - Mounting

SM = screw mounting (standard).
 VM = concealed mounting (standard for faceplate made of aluminium, only possible with plenum box, plenum box can also be provided on site).

11 - Hit-and-miss damper

SN = without hit-and-miss damper (standard).
 SS = with hit-and-miss damper.

12 - Ball-impact guard

B0 = without ball-impact guard (standard).
 BS = with ball-impact guard (not possible for DBB-...-AL-ELOX).

ORDER CODE AK

01	02	03	04	05	06	07
Type	Air diffuser	Length	Height	Single / band design	Mounting	Material
Example						
AK	-50	-00625	-115	-N	-SM	-SV

08	09	10	11	12	13
Damper	Rubber lip seal	Insulation	Height of plenum box	Spigot diameter	Spigot position
-DK1	-GD1	-I0	-KHS	-SDS	-S1

All fields must be filled when ordering.

Sample

AK-50-00625-115-N-SM-SV-DK1-GD1-I0-KHS-SDS-S1

Plenum box, rectangular design I for ceiling air diffuser DBB-...-Z...(supply air) I length 625 mm I height 115 mm I single design I screw mounting I galvanised sheet steel I with damper I with rubber lip seal I without insulation I standard height of plenum box I standard spigot diameter I lateral spigot on the plenum box

ORDER DETAILS

01 - Type

AK = plenum box, rectangular design

02 - Air diffuser

48 = for ceiling air diffuser DBB-...-A...(return air)
(inside painted to RAL colour 9005 [black])

50 = for ceiling air diffuser DBB-...-Z...(supply air)
(with integrated perforated straightener)

03 - Length

00325 = length 325 mm

00425 = length 425 mm

00525 = length 525 mm

00625 = length 625 mm

00825 = length 825 mm

01025 = length 1025 mm

01225 = length 1225 mm

xxxxx = length in mm, freely selectable, for band design
(for length BL > 1225 mm: 2-part for a length of
band BL ≤ 2437 mm, multi-part for a length of
band > 2437 mm) (always with 5 digits).

04 - Height

115 = height 115 mm

215 = height 215 mm

315 = height 315 mm

05 - Single / band design

N = single design (standard)

B = band design (for length BL > 1225 mm, available
lengths according to SCHAKO standard for band
design).

06 - Mounting

SM = screw mounting (standard, screws must be
provided on site).

VM = concealed mounting.

07 - Material

SV = galvanised sheet steel (standard).

08 - Damper

DK0 = without damper (standard).

DK1 = with damper (standard for spigot position -S1).

DK2 = with damper and cable-operated adjustment
(standard for spigot position -S0 / -S4).

09 - Rubber lip seal

GD0 = without rubber lip seal (standard).

GD1 = with rubber lip seal.

10 - Insulation

I0 = without insulation (standard).

Ii = with internal insulation.

Ia = with external insulation.

11 - Height of plenum box

KHS = standard height of plenum box.

xxx = height of plenum box in mm, freely selectable
(minimum height [KHS] with spigot positions -S1
and -S4 = spigot diameter + 87 mm, but at least 200
mm) (always with 3 digits).

12 - Spigot diameter

SDS = spigot diameter standard.

xxx = spigot diameter in mm, freely selectable (always
with 3 digits) (with spigot positions -S0 and -S4, if
the spigot diameter is increased, only the offset
plenum box shape is available).

13 - Spigot position

S0 = spigot from above.

S1 = lateral spigot on the plenum box (standard).

S4 = front side spigot (not possible for band design).

SPECIFICATION TEXT

Ceiling air diffuser type DBB for supply and return air, in rectangular design, free cross-section, resistance and noise level remain constant in all blade positions. Consisting of faceplate with individually adjustable pivoting air deflection blades.

Product: SCHAKO type DBB-...

Model:

- longitudinal slots only (-A).
- longitudinal slots and transverse slots on one side (-B). (available from length 425 mm / height 215 mm)
- longitudinal slots and transverse slots on both sides (-C). (available from length 425 mm / height 215 mm)

Air throw:

- supply air 1-way (for DBB-A) (-Z1)
- supply air 2-way (for DBB-A and DBB-B) (-Z2)
- supply air 3-way (for DBB-B and DBB-C) (-Z3)
- supply air 4-way (for DBB-C) (-Z4)
- return air, without blades (-AA)
- return air with blades (-AB)

Length:

- 325 mm (-00325)
- 425 mm (-00425)
- 525 mm (-00525)
- 625 mm (-00625)
- 825 mm (-00825)
- 1025 mm (-01025)
- 1225 mm (-01225)
- length in mm, freely selectable, for band design (for length BL > 1225 mm: 2-part for a length of band BL ≤ 2437 mm, multi-part for a length of band > 2437 mm) (always with 5 digits).

Height:

- 115 mm (-115)
- 215 mm (-215)
- 315 mm (-315)

Single / band design:

- single design (-N) (standard)
- Band design (-B) (available lengths according to SCHAKO standard for band design) (for length BL > 1225 mm, module length max. 1225 mm, only possible for model DBB-A).

Material / paint (faceplate):

- Sheet steel (-SB):
 - painted to the RAL colour 9010 (white, standard) (-9010).
 - painted to another RAL colour, freely selectable (-xxxx)
- Galvanised sheet steel (-SV-0000) (only possible without paint).
- Natural colour anodised aluminium (E6/EV1, only possible with concealed mounting, only possible with ELOX paint) (-AL-ELOX)

Blade colour:

- Without blades (-00000) (standard for return air).
- Plastic:
 - similar to RAL colour 9005 (black) (-L9005).
 - similar to RAL colour 9010 (white, standard) (-L9010).
- Aluminium:
 - painted to the RAL colour of the faceplate (at an extra charge). The painted blades cannot be adjusted subsequently (-Axxxx) (always with 5 digits).
 - natural colour anodised (-AELOX).

Mounting:

- Screw mounting (-SM, standard)
 - screws must be provided on site.
- Concealed mounting (-VM, standard for faceplate made of aluminium).
 - only possible with plenum box (plenum box can also be provided on site).
 - the counter pole brace to be provided by customer when delivered without plenum box.
 - In concealed mounting, the ceiling air diffuser is fixed to the plenum box with a pole brace and hexagonal socket head screws (DIN EN ISO 4762 M6).

Accessories:

- Plenum box, in rectangular design, made of galvanised sheet steel (-SV, standard), housing with round connection spigot and mounting brackets.
 - Air diffuser:
 - for ceiling air diffuser DBB-...-A... (return air) (-48) (inside painted to RAL colour 9005 [black]).
 - for ceiling air diffuser DBB-...-Z... (supply air) (-50) (with integrated perforated straightener).
 - Length:
 - 325 mm (-00325)
 - 425 mm (-00425)
 - 525 mm (-00525)
 - 625 mm (-00625)
 - 825 mm (-00825)
 - 1025 mm (-01025)
 - 1225 mm (-01225)
 - length in mm, freely selectable, for band design (for length BL > 1225 mm: 2-part for a length of band BL ≤ 2437 mm, multi-part for a length of band > 2437 mm) (always with 5 digits).
 - Height:
 - 115 mm (-115)
 - 215 mm (-215)
 - 315 mm (-315)
 - Single / band design:
 - single design (-N) (standard).
 - band design (-B) (for length BL > 1225 mm, available lengths according to SCHAKO standard for band design).
 - Mounting:
 - Screw mounting (-SM) (standard, screws must be provided on site).
 - concealed mounting (-VM).

- Damper:
 - without damper (-DK0) (standard).
 - with damper (-DK1), made of galvanised sheet steel, in the plenum box housing, adjustable, for simple air volume regulation. Standard with lateral spigot position (-S1).
 - with damper (-DK2), same as DK1, but with cable-operated adjustment, standard with spigot position from above (-S0) and front side spigot position (-S4).
- Rubber lip seal:
 - without rubber lip seal (-GD0) (standard).
 - with rubber lip seal (-GD1) made of special rubber, at the connection spigot.
- Insulation:
 - without insulation (-I0) (standard).
 - with internal insulation (-Ii), thermal insulation inside the plenum box.
 - with external insulation (-Ia), thermal insulation at the outside of the plenum box.
- Height of plenum box:
 - Standard height of plenum box (-KHS).
 - height of plenum box in mm, freely selectable (-xxx) (minimum height [KHS] with spigot positions -S1 and -S4 = spigot diameter + 87 mm, but at least 200 mm) (always with 3 digits).
- Spigot diameter:
 - Standard spigot diameter (-SDS).
 - spigot diameter in mm, freely selectable (-xxx, always with 3 digits) (with spigot positions -S0 and -S4, if the spigot diameter is increased, only the offset plenum box shape is available).
- Spigot position:
 - Spigot from above (-S0).
 - Lateral spigot on the plenum box (-S1) (standard).
 - Front side spigot (-S4, not possible for band design).
- Hit-and-miss damper (-SN / -SS)
 - without hit-and-miss damper (-SN) (standard).
 - with hit-and-miss damper (-SS)
 - for air volume regulation, made of galvanised sheet steel.
 - VM model is only possible with plenum box or on-site counter pole.
- Ball-impact guard (-B0 / -BS)
 - without ball-impact guard (-B0) (standard).
 - with ball-impact guard (-BS)
 - not possible for DBB-...-AL-ELOX.
 - made of steel painted to the RAL colour of the faceplate.